

OXFORD
UNIVERSITY PRESS

TEACHER'S MANUAL

MASTERY IN MATHEMATICS THROUGH THE CONCRETE
PICTORIAL ABSTRACT (CPA) APPROACH

2

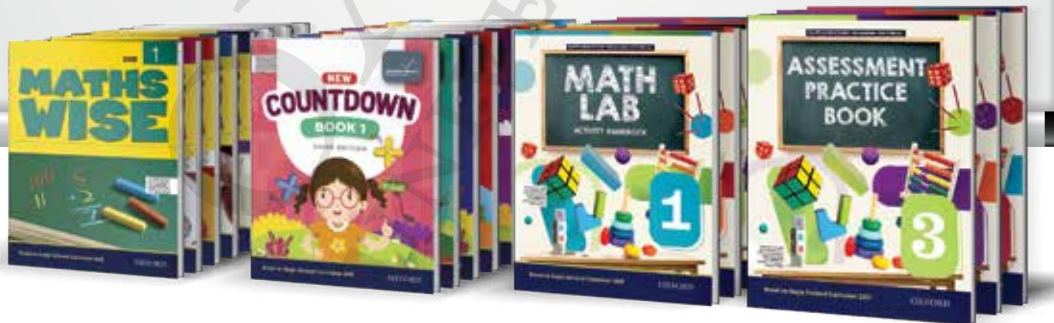

OXFORD
UNIVERSITY PRESS

Contents

Title	Page
Our core philosophy	4
Tackling Math Anxiety and Avoidance	6
Inclusivity in the Class	7
Single National Curriculum / National Curriculum of Pakistan 2020	10
Unit 1: Whole Numbers	14
Unit 2: Number Operations	22
Unit 3: Fractions	36
Unit 4: Measurement: Length, Mass, and Capacity	41
Unit 5: Time	50
Unit 6: Geometry	57
New Countdown 2: Lesson Plans	65
Features of the Teaching Guide	66
Unit 1: Whole Numbers	69
Unit 2: Addition	71
Unit 3: Subtraction	74
Unit 4: Multiplication	77
Unit 5: Division	79
Unit 6: Fractions	81
Unit 7: Measurement: Length, Mass, and Capacity	83
Unit 8: Time	89
Unit 9: Geometry	91
Maths Wise 1: Lesson Plans	93
Unit 1 — Unit 8	95 –129
Worksheets	131 –154
Answers: Unit 1 — Unit 8	155
Glossary	170

Our Core Philosophy

This Teacher's Manual has been designed to promote good teaching practices for teachers to implement the SNC/ NCP 2020. This series provides teachers with the flexibility to choose the elements that are right for their learners.

Teachers must create a conducive environment for learning mathematics in the class that rewards creativity and enjoyment. When introducing a concept, teachers need to ensure that pupils can relate mathematical activities and problems. Therefore, teaching mathematical concepts with real-life context and providing hands-on experience facilitates the learning process, so long as the context is comprehensible to the class. Pupils should be able to find solutions to real-life situations based on what they have learnt in class. This series engages pupils by providing interactive hands-on activities, as well as individual exercises. Each unit in the book ends with a class discussion, inviting pupils to share their perspective, and all concepts are supported by real-life tie ins. This approach begins by each pupil having an opinion, and at each unit's end, they can discuss how their opinions have changed, and whether they see the importance of what they learnt. The heavy focus on inquiry-based learning, demonstration approach, and cooperative learning allows the teacher to expose the class to different teaching styles, which ultimately help pupils to better understand their own needs as learners. The Teachers' Manual provides instructions on the use of resources to help them carry out the above-mentioned objectives. If a concept is taught in a comprehensive manner with clear instructions along with hands-on activities and practice, most pupils would be able to achieve the set assessment target. Each pupil has a set pattern and pace of grasping concepts, but the expectation is the plateau of mathematical competency for all. In this regard, the manual serves as a support for teachers regardless of what series they use.

The Teacher's Manual supports a meaningful and holistic approach to teaching the strands of mathematics. The build-up of concepts throughout this series is progressive and thorough. With the implementation of hands-on activities, the learning of a mathematical concept is complemented with experiences that make learning mathematics enjoyable and give pupils the ownership of independent and group practices. Multiple strategies, in the form of games, standard and non-standard materials, and resources, are implemented through activities. The Teacher's Manual facilitates teachers to implement this aspect of the series proficiently. It also provides a structure whereby teachers and coordinators can select, combine, and improvise various pedagogical practices for the pupil-centric textbook and workbooks. In this regard, the Teacher's Manual provides the following elements:

- **Aligned with SNC/ NCP 2020** – SLOs listed at the start of each unit, as well as next to each activity in the margins.
- **Unit Guides** – Detailed lesson plans for each lesson to keep the teaching approach organised and accessible for the teachers. It encompasses prior learning, pre-emptive pitfalls, introduction, and problem solving.
- **Inclusivity in the Class** – An essay detailing some of the most prevalent disabilities in schools. How to see the signs, and how to make sure your class is a good learning environment for all your pupils.
- **Tackling Math Anxiety and Avoidance** – Math should be taught in a fun and inviting way, and to do it right, one must understand what not to do. This write-up discusses all the contributors of Mathphobia, as well as how to see the signs of it in pupils.
- **Let's Begin** – An introductory paragraph to start a class discussion, preparing the class to break into a new unit.
- **Activities** – Structured activities designed to make sure that pupils learn everything they need to know in an interactive on way.
- **Let's Try It** – Class exercises for pupils' individual or pair work so they can practice concepts as they learn them.

- **Let's Talk Math** – Mathematical communication support. Real-life connections are necessary for pupils to really appreciate the math that they are learning. This will help you start a conversation at each unit is end, bringing the topic to conclusion, as well as leading pupils to reflect on what they learnt.
- **Let's Get Practical** – An end-of-unit activity that incorporates a real-life connection, including as many SLOs as possible.
- **Confusion Bar** – A bar that ranks confusion levels from 1 to 5, both reminding the teacher to check in, as well as allowing them to track the number of pupils whose understanding is not up to par.
- **Math Lab** – Alongside our activities, we list page numbers from Math Lab; an activity handbook that might help struggling pupils, and help all pupils practice their concepts.
- **Self Assessment** – Given at the end of each unit, a page for the teacher to assess how well the class has understood the lesson, in accordance with the SNC/ NCP's "Role of a Teacher".

A user-friendly guide to the SNC/ NCP to help teachers perform to the best of their abilities, and to remind pupils that there is a place for creativity in math. It is crucial that children build a good relationship with the subject at early stages, given that there is so much of it in day-to-day life, and a solid foundation would be very helpful for later years.

OXFORD
UNIVERSITY PRESS

Tackling Math Anxiety and Avoidance

The fact that it is common for students to struggle with math is often written off as nothing more than a difficult subject being neglected by unmotivated students. Surely, if children put in the necessary practice time, they would succeed at whatever they tried. Or perhaps some children are unable to comprehend ideas so complex because they are not smart enough.

Researchers believe that about 20 % of people suffer from “math anxiety” and some psychologists believe it to be a diagnosable condition. Math anxiety will most likely lead to “math avoidance”. Students will often appear unfocused, like they are looking for reasons to leave the class. It might look like they would prefer anything to try to learn the material. They may also appear to be lazy or naughty, but the fact is, these children are just looking for an escape from a stressful situation. They do not ask for help or guidance because they do not believe they have any chance of doing better, and because they feel unable to confront their fears. The stress that they feel during class also impacts their ability to learn. Children are already so susceptible to distractions that a high stress situation can almost entirely block their working memory. Furthermore, these feelings are not simple enough for young children to be able to explain to adults, even if they are offered help. What they understand is that they are low achievers, they are bad at math, and they will always be bad at math.

When trying to understand how to fix or avoid the anxiety associated with math in the class, here are some things you should keep in mind:

Math Anxiety is Contagious

As a teacher, if you start seeing math avoidance, ask yourself what might have triggered it. Is the overall class attitude toward math negative? How did it become that way? It is not uncommon for the idea to be picked up from the teacher. That is why it is important to never present the subject as something that students should worry about. Do not tell your students that the next unit is difficult. Instead, give them the lesson, and let them ask questions so they know that it is not a big deal to ask for help.

Do Not Promote the Idea That Some People are Just Not Good at Math

Also, be sure to reassure your students that everyone is different, but everyone can do math. Remind them that it is not their fault if something did not make sense the first time because all people have different ways of learning. Or better yet, tackle new topics by catering to multiple learning styles. Incorporate some activities and some creativity so that at the end of the introduction, they will all have a clearer idea of the concept.

Avoid Shame in the Class

One of the bigger roots of stress in the class is the fear of failure. Instead of calling out children by name and asking them to answer a question in front of the class, ask the question and allow them to raise their hands. If you notice some children that do not tend to volunteer, check their written work to see how they are performing. If they are doing well, then they are simply not comfortable speaking up in front of their classmates and maybe just need a confidence boost. If they are not performing well, then you are more likely dealing with avoidance.

Group Weaker Students with Students that Could Help Them

When doing group exercises in the class, make sure the students who are struggling are evenly distributed. Often, they will feel more comfortable approaching their peers for help, or might even learn from watching them, because they will not be feeling as though they are the ones faced with the problem. Furthermore, children have a better idea of what was challenging about a subject than an adult. They may be able to clear up some confusion for their friends that the teacher was not aware of.

Students Who Experience Math Anxiety Can Actually Be Good at Math

Do not think of these children as underachievers. Instead, think of them as students who have something crucial missing from their learning process. Instead of repeating the same explanation, try to use different language, or better yet, design an experience that will show them what you are trying to explain. Keep in mind that anxieties are impacting students’ comprehension skills, so your approach must be something that helps students feel like there is less pressure to succeed.

Inclusivity in the Class

Every student is differently abled, and as teachers, we try multiple approaches to cater to each one of them. However, some students need special consideration. Below are some examples of students who could be held back in the class due to their special needs, and small considerations that could be made that might make all the difference without compromising on learning objectives. Be sure to be aware of exactly how severe the impact is before deciding what changes to make. The goal here is to create an environment where the children can adapt to life amongst abled people, and learn to be as independent as possible, which is why one should try to avoid extra attention. Children should never believe that they are not able to do things, and instead be given the tools to find ways to do things.

Sight

While it is commonly believed that visually impaired or blind students need constant help, teachers should keep expectations high, while still making it clear that it is always alright to ask for help, as is for regular students. Any changes or adaptations should apply to the entire class, to avoid singling anyone out.

Some good practices to incorporate are being more verbal, especially when writing on the board, and always calling children by their names rather than pointing. When the illustrations in the book are pertinent to the lesson, describe them aloud to the entire class so that no one misses out. If possible, use tangible objects, such as counters, so that the class is not entirely reliant on images. If you do see these students struggling, instead of rushing in to help, offer information to the entire class, for example, if the child is having trouble finding a book, describe the shape instead of getting it for him or her.

Hard of Hearing

Depending on when these children lost their hearing, they may be lacking in vocabulary, and have trouble speaking.

Seat these students near to the front of the class since they will be almost entirely reliant on the blackboard, and they may be able to lipread if they have clear sight of the teacher. Therefore, the teacher should always face the class when speaking, and also, keep in mind that hearing-impaired students cannot listen and take notes simultaneously, especially if watching an interpreter. If possible, make sure important information is also available as handouts, including class announcements about deadlines and scheduling. Furthermore, any videos or documentaries screened at school should have subtitles.

Speech

These students will need some facilitation when encountering new vocabulary. It might be helpful if before starting a new unit, there is five-minute class discussion about the unfamiliar terminology that might pop up so that they can make note of it. Always ask students if they need help before assuming that they do. If they can successfully complete a task that involves communication, praise them, but do not draw too much attention as if it was unexpected. It might seem necessary to eliminate verbal assessments for these students but be cautious about this. There should always be an opportunity for the student to attempt to improve, or practice their communication abilities, and they should feel comfortable doing so. Small improvements should be acknowledged, and the goal should remain to meet the learning objectives however possible.

Memory

To help these students, one must understand the difference between working short-term and long-term memory. When a student learns new information, it is initially stored in working memory, as he or she uses it, and with time, as it stops being pertinent to their actions, it shifts to long term memory. If the child can recall concepts that were taught within the last 24 hours, but struggling to remember information from two weeks ago, then the issue lies with their long-term memory. If it is the other way around, like if they are forgetting instructions they were just given, then it is their working memory that is the problem.

While it has a bad reputation, rote learning can be very helpful for these students. Even employing repetition to really drill things into their minds might be helpful. The more modern approaches like project-based learning will certainly help them grasp concepts, but those concepts need to stick in their minds, so constantly relating new material to what was learned previously, and revising will help achieve this. Also, encourage active reading when assigning homework. Ask students to make notes while reading so that they can engage more with the text and have a personalized reference point when they need to revise. Lastly, create associations. Make games out of math activities, sing songs, use acronyms, and relate math to real-life. These students might have to work slightly harder on their own time, but these small changes to the class will both encourage and facilitate this.

Dyslexia, Dyscalculia, and Dysgraphia

While these learning disabilities are estimated to affect 5 to 20% of people globally, they often go undiagnosed. Since students are not aware that the way they perceive things is different, as a teacher, one must be aware of the signs.

a) Dyslexia

causes problems with reading, writing, and spelling. Some signs to look out for are delayed speech development, trouble pronouncing words, for example, saying “taplop” instead of laptop, trouble with sentence construction, even verbally, and lack of appreciation for rhymes. These children will often seem disinterested in learning the alphabet as they would not be able to comprehend it as well as their peers.

b) Dyscalculia

a range of difficulties with maths. Students may not immediately understand the meaning of numbers and applying mathematical principals. To identify students suffering from it, look out for children who lose track when counting, and rely heavily on visual aides, like fingers when counting. Placing objects in order, and connected numerals (7) with written out words, like seven will be a struggle for these children.

c) Dysgraphia

affects the act of writing that requires a set of motor and information processing skills. The signs include problems with spelling, handwriting, and expressing thoughts on paper, because students will not be able to think and write at the same time. Their writing will show an inconsistency in spacing, and missing words and letters. An unusual hand position while writing or keeping the paper at an angle is also a symptom.

All these learners will be different. Some may be able to get by in a normal class environment, while some will need special allowances. For instance, allowing the student to bring in an audio recording device would be very helpful. Furthermore, providing a multisensory learning experience will make it less likely that they will miss certain things entirely. It is imperative that these allowances are only made where necessary, and that, as often as possible, they apply to the entire class, as opposed to just one or two students.

Autism

When dealing with Autism, one must keep in mind that it is a spectrum, and that it will be different in every student. Some children are diagnosed early on as their Autism affects their every day lives, but some are not diagnosed until quite late in life, as the symptoms vary both in nature and in visibility.

Students who make little or no eye contact, are not able to interact with others, repetitive movements (like flapping arms, or tapping), have low spatial awareness, and are extra sensitive to bright lights and sounds might be on the spectrum. While only a professional can make a diagnosis, proper medical help is not always accessible, and parents do not always notice the signs. Autistic children are often also prone to tantrums, and can come across as insensitive, and or, unemotional.

While this is a complicated disorder, small efforts can go a long way in helping these students thrive. Highly structured environments, following a routine, and giving plenty of warning before big changes will make these students feel more comfortable and able to focus on subject matter. Limit class distractions and give written instruction instead of long verbal announcements. These children express themselves differently, but often are very intelligent and passionate. Approaching their learning with a positive attitude will do wonders for them.

ADHD (Attention Deficit/Hyperactivity Disorder)

ADHD is a disorder that leads to problems paying attention, impulse control, and hyperactivity. While all children are easily distracted, it will be especially apparent in these children. Like Autism, a diagnosis can only be made by a professional, but since not all children will have that privilege, teachers can facilitate their learning by making the class environment as stable and predictable as possible.

The instructions given in class should always be clear, and if possible, consistent. All students should understand what is expected of them, and this should be repeated as often as it seems necessary. Furthermore, instead of just verbally communicating them, also put them up in the room so that students can refer to them whenever they need to. A good tool is to have the children tell you what they understood was or is expected of them, as children often listen without absorbing, and children with this particular disorder may be skilled at appearing engaged, whereas their mind is actually elsewhere.

OXFORD
UNIVERSITY PRESS

Single National Curriculum/ National Curriculum of Pakistan 2020

The curriculum for Mathematics is comprised of the following four strands. The strands are intentionally kept broad to allow flexibility to the teachers to adapt their teaching styles in accordance with their students.

These strands include Numbers and Operations, Algebra, Geometry and Measurement and Data Handling. All of this content is underpinned by reasoning and logical thinking. All standards, benchmarks and students' learning outcomes are built around these strands.

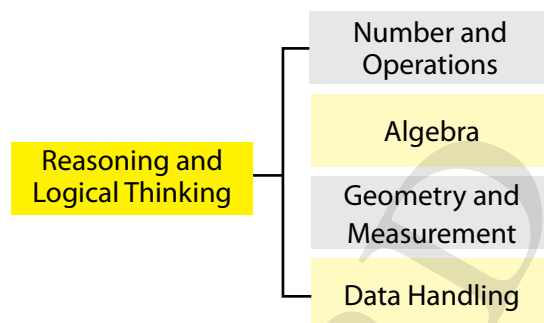

Key Learning Strands	Standards
1. Numbers and Operations	<ul style="list-style-type: none"> identify numbers, ways of representing numbers, comparing numbers and effects of number operations compute fluently with fractions, decimals and percentages examine real-life situations by identifying mathematically valid arguments and drawing conclusion to enhance their mathematical thinking
2. Algebra	<ul style="list-style-type: none"> analyse number patterns known facts, properties and relationships to analyse mathematical situations examine real-life situations by identifying mathematically valid arguments and drawing conclusion to enhance their mathematical thinking
3. Geometry and Measurement	<ul style="list-style-type: none"> identify measurable attributes of objects, construct angles and two-dimensional figures analyse characteristics and properties of geometric shapes and develop arguments about their geometric relationships examine real-life situations by identifying, mathematically valid arguments and drawing conclusion to enhance their mathematical thinking
4. Data Handling	<ul style="list-style-type: none"> collect, organise, analyse, display and interpret data/ information examine real-life situations by identifying mathematically valid arguments and drawing conclusion to enhance their mathematical thinking

The Mathematics Curriculum Standards and Benchmarks – SNC/ NCP 2020

The Standards for Mathematics are further sub-divided into the following Benchmarks for Grade I – V.

Standards	Benchmarks Grade I – III	Benchmarks Grade IV – V
<p>Numbers and Operations</p> <ul style="list-style-type: none"> • identify numbers, ways of representing numbers, comparing numbers and effects of operations in various situations. • compute fluently with fractions, decimals and percentages • examine real-life situations by identifying mathematically valid arguments and drawing conclusion to enhance mathematical thinking 	<p>The students will be able to:</p> <ul style="list-style-type: none"> • identify, read and write whole numbers up to 10,000 • read and write Roman numbers up to 20 • identify and differentiate even and odd numbers up to 99 • arrange, compare numbers up to 3 digits using symbols (<, > or, =) • identify and recognise place values up to 5-digit numbers • represent and identify the given number on number line • round off a number to the nearest 10 and 100 • add, subtract numbers up to 4 digits • develop multiplication tables up to 10 • multiply number up to 2 digits with 1-digit numbers • recognise and use of division symbol, divide up to 2-digit numbers by 1-digit number • solve real-life situations involving addition, subtraction, multiplication, and division • recognise fractions and different forms of fractions with the help of objects and figures 	<p>The students will be able to:</p> <ul style="list-style-type: none"> • read and write whole numbers up to 1,000,000 (1 million) in numerals and words • add and subtract numbers of different complexity and of arbitrary size • multiply and divide numbers, up to 6 digits, by 2 or 3-digit numbers and by 10,100 and 1000 • solve real-life situations involving operations of addition, subtraction, multiplication, and division • recognise and differentiate between factors and multiples of two or three 2-digit numbers • find highest common factor (HCF) and least common multiple (LCM) of two, three, or four numbers, up to 2-digits • solve real-life situations involving HCF and LCM • recognise and compare like and unlike fractions • arrange, convert and simplify fractions • add, subtract, multiply and divide fractions • solve real-life situations involving addition, subtraction, multiplication and division of fractions

Standards	Benchmarks Grade I – III	Benchmarks Grade IV – V
	<ul style="list-style-type: none"> • express and match fractions in figures and compare fractions with same denominators using symbols $<$, $>$, or $=$ • identify and write equivalent fractions for a given fraction • add and subtract two fractions with same denominators 	<ul style="list-style-type: none"> • apply unitary method for solving real-life situations • identify and recognise decimal numbers • convert decimal numbers into fractions and vice versa • add and subtract numbers up to 3 decimal places • multiply and divide decimal numbers with whole numbers • round off decimal numbers up to specified number of decimal places • solve real-life situations involving decimal numbers (up to 3 decimal places) • convert percentage to fraction and to decimal and vice versa
<p>Algebra</p> <ul style="list-style-type: none"> • analyse number patterns • known facts, properties and relationships to analyse mathematical situations • examine real-life situations by identifying mathematically valid arguments and drawing conclusion to enhance mathematical thinking 	<ul style="list-style-type: none"> • develop the concept of equality using addition and subtraction of numbers • identify and complete geometrical patterns on square grid according to attributes like shape, size and orientation 	<ul style="list-style-type: none"> • develop the concept of equality using addition, subtraction, multiplication, and division of numbers • identify and describe repeating pattern using relationship between consecutive terms and generate number patterns

Standards	Benchmarks Grade I – III	Benchmarks Grade IV – V
Geometry and Measurement <ul style="list-style-type: none"> • identify measurable attributes of objects, construct angles and two-dimensional figures • analyse characteristics and properties of geometric shapes and develop arguments about their geometric relationships • examine real-life situations by identifying, mathematically valid arguments and drawing conclusion to enhance mathematical thinking 	<ul style="list-style-type: none"> • use language to compare heights/ lengths, masses and capacity of different objects • read, recognise and use units of length (kilometre, metre and centimetre), mass (kilogram and gram) and capacity (litre and millilitre) and time (minute and second) • add and subtract in units of length, mass, capacity and time for solving real-life situations • use solar and Islamic calendar to find a particular date/ day • recognise and identify two- and three-dimensional figures • determine perimeter of square, rectangle, and triangle • identify and differentiate straight line and curved line • identify and draw points, lines, line segments, and rays • identify and describe symmetrical shapes 	<ul style="list-style-type: none"> • convert standard units of length, mass, capacity, and time • solve the real-life situations involving addition and subtraction of units of distance/ length, mass, capacity, and time • distinguish parallel and non-parallel lines • identify, classify and construct different types of angles • describe and classify 2-D figures and 3-D geometrical objects • determine perimeter and area of square and rectangle • describe and complete symmetric figures with respect to given line of symmetry and point of rotation

Standards	Benchmarks Grade I – III	Benchmarks Grade IV – V
Data Handling <ul style="list-style-type: none"> • collect, organise, analyse, display and interpret data/ information • examine real-life situations by identifying mathematically valid arguments and drawing conclusion to enhance mathematical thinking 	<ul style="list-style-type: none"> • read, interpret and represent data using Carroll diagrams, picture graphs and tally charts 	<ul style="list-style-type: none"> • read and interpret bar graphs, line graphs and pie charts • represent real-life situations using pie chart • find an average of given quantities in the data • draw and read simple bar graphs both in horizontal and vertical form • solve real-life situations using simple bar graphs

Note: Lifted from SNC/ NCP document. To learn more about the SNC/ NCP go to mofept.gov.pk, choose curriculum, then SNC/ NCP, the Pakistan National Curriculum. Click on maths 2020 to open the document.

Unit 1

Whole Numbers

1.1 Ordinal Numbers

- i. Write ordinal numbers from first to twentieth
- ii. Write numbers 1 to 100 in words.

1.2 Numbers up to 100

- i. Read numbers up to 999.
- ii. Write numbers up to 999 as numerals.
- iii. Recognise the place value of a 3-digit number.
- iv. Identify the place value of a specific digit in 3 digit numbers.
- v. Compare 2-digit numbers with 3-digit numbers (hundreds, tens, and ones).

- vi. Compare 3-digit numbers with 3-digit numbers (hundreds, tens, and ones).
- vii. Count backward ten steps down from any given number.
- viii. Arrange numbers up to 999, written in mixed form, in increasing or decreasing order.
- ix. Count and write in 10s (e.g. 10, 20, 30, ...).
- x. Count and write in 100s (e.g. 100, 200, 300, ...).
- xi. Identify the smallest/largest number in a given set of numbers.
- xii. Recognise that 1000 is one more than 999 and the first 4-digit number.

Plan Ahead:

- 1.1 Ordinal Numbers
- 1.2 Numbers up to 100

Allocate realistic time frame/number of periods to teach each topic as per requirement.

Before You Start:

Pupils must have knowledge of numbers 0 to 100, meaning they can write them in words, as well as numerals. They will also be familiar with ordinal numbers, although only up to 10, and number patterns, having previously learnt to count backwards in tens.

Watch Out For:

Some pupils might have trouble adjusting to 3-digit numbers, so they may need some extra practice to get comfortable with them. This unit also introduces hundreds of new numbers to spell, but they are all words that pupils can already spell.

This Pairs with:

Math Lab 2, page 2 to 22.

Make Sure You Have:

2 and 3-digit number cards Balls
Baskets/bags Coin

If They are Struggling:

Spell the numbers out loud in class, and instead of chanting, ask for individual responses. Also, encourage pupils to break up numbers. Six hundred and thirty-four might seem like a brand-new spelling, but they already should know how to spell six, hundred, and thirty-four. The spellings that may be new include the word thousand, and all the ordinal numbers after tenth. Spelling tests should be a good way to keep these spellings from being forgotten. To help with placement, colourful number lines, as well as other visuals could be helpful. When you see the confusion bar, take note of how many pupils fall under each level. If pupils are at a level 3 or below, have them solve the equivalent Math Lab pages in pairs, having weaker students work with more confident students. First do allow the class to collectively ask questions. If all pupils are at a 4 or above, move on to the next activity.

Let's Begin

Ask pupils what is the biggest number they can think of. Some of them will repeat what they have learned in class, while some may volunteer information planned at home. Let them challenge each other's ideas and discuss for about 30 seconds, before drawing a number line on the board. Then ask them what is the biggest number they have learned in class is. The answer should be 100. Label the number line with 0 on the left, 50 in the middle, and 100 and the end. Ask the class if anyone knows how to write the number after 100. Tell them that they are welcome to guess if they are not sure. If they do know, extend the number line slightly and write 101 on the board. Write up to 111, and explain that in the tens, the last digit goes up by only one, so it is the same in the hundreds. Invite volunteers to the board to write (in numerals) 102 to 120. Once this is done, ask the pupils if they have any idea how these numerals are read. Give them some time to guess, but if they are not able to figure it out, read the numbers aloud and have them repeat after you. They might find it strange that the word "and" is present in a number but tell them that this should only make it easier to remember. To make it simpler for them to understand, explain that the last two digits of all the numbers are said and written just as they are in between 0 and 99. The fact that they now have a 1 before them simply means that they now must be said as "one hundred and..."

1.1
i
ii

Activity 1

20 min

This pairs with Math Lab page 2

Give pupils a word list of numbers 1 to 100 and ordinal numbers 1 to 20. Make groups of. Since they already know most of these spellings, allow them one day to revise at home. The next day, hold a spelling bee in class. Tell them that you will be saying a number aloud, and they may discuss the spelling amongst each other, within their groups. Explain them that from every group, group member will be allowed to answer. The chosen group member will have 10 seconds to write the number on the board correctly. If they are wrong, another group will have a chance to raise their hand. If the group spells the number correctly in the first attempt, they will be rewarded 5 points. However, if they get it right in the second attempt, they will be awarded 3 points.. If after the third attempt, the number has still not been spelled correctly, make note of it so that you can be sure to go over it later. Do as many numbers as possible, but do not spend more than 20 minutes on this activity. At the end, award the titles first, second, and third.

Tell pupils that they should be prepared for random spelling tests throughout the next couple of weeks for the numbers 1 to 100, and ordinal numbers 1 to 20. Whenever there is free time at the beginning or end of the class, do 10 to 20 words at a time. This way, pupils will be sure to keep revising the spellings, and remember them. Do not stretch this objective more than four weeks, and make sure that all the words are covered.

**Let's
Pause**

If pupils are not able to figure out the place value of hundreds write, 1 on the board and point out that it falls into the category of ones. Then write a 10 and point out that the 1 in 10 falls into the category of tens. At this point they will hopefully have noticed the pattern, so when you write 100 on the board, and ask them what the place value of the 1 is, they should be able to guess hundreds.

1.2
i
ii
iii
iv

Activity 2

15 min

Remind the class about place values in 2-digit numbers. Then ask a volunteer to write any 2-digit number on the board. Point to one digit at a time and ask them what they think the place value of that digit is. Go from smallest to biggest. Once the place values have been written on the board, add 1 in front of the number, making it a 3-digit number. Tell them that if the right most digit is in the ones, and the middle one is in the tens, what category do they think the left most digit should fall into. Give them some time to guess that it is in hundreds, and if they don't, refer to the Let's Pause above to help them get to that conclusion on their own. Call out numbers between 100 and 999 and call on pupils individually to write them on the board and point out the place value of each digit as they write it. Make sure every child has a turn.

Let's try it

Call out 3-digit numbers at random and ask pupils to only make note of the digit that is in the tens. After ten numbers, switch to the hundreds, and do ten more numbers. Have pupils compare work to make sure there are no mistakes.

SLOs

1.2
v
vi

Ask the pupils to write the numbers 100 to 999 in their notebooks as homework, but break it up into 100 to 250, 251 to 500, 501 to 750, 751 to 999. Assign these over the course of two weeks, and do not assign any other homework as they are doing this.

This pairs with Math Lab page 19

Activity 3

15 to 20 min

Put 2-digit and 3-digit numbers on pieces of paper, or cards, and place them face down at the front of the class. Ask pupils to pair up and tell them you will be playing a game of more than or less than. This is how the game will work: a pair will come to the front of the class, and the teacher will flip a coin. If the coin lands on heads, the larger number will win. If it lands on tails, the smaller number will win. The pair will have to pick one card each and hold them to their foreheads, so everyone but them can see what number they have. Make sure the numbers are written clearly enough for the entire class to be able to see or have the rest of the pupils move forward. Once the cards are on their foreheads, the class will have to identify the winner. Ensure that you put enough cards down so that each pupil gets a new number, and once one has been picked up, remove it from the pile so that it is not repeated. Also, be sure to put in only about a third as many 2-digit numbers as 3-digit numbers.

Refer to If they are struggling	Confusion level	1 – Does not understand any concept	2 – Does not understand most of the concepts	3 – Understands some concepts but has questions	4 – Understands all the concepts, just needs more practice	5 – Feels confident solving questions	If pupil is below 3 use Math Lab
	Number of Pupils						

1.2
vi

Activity 4
15 min

This pairs with Math Lab page 22

Using the 3-digit number cards from the previous activity, ask the pupils how they would find a number 10 steps down from these numbers. They may initially be nervous about the size of the numbers but remind that they only need to go down ten steps. Start with numbers like 175 where only the middle digit will change. Tell them that they can ignore the 1 and should just focus on finding the number ten steps down from 75. Remind them that place values will help here. Since 7 is in the place of the tens, that should go down by 1 ten, so the answer should be 165. Only explain this to them if they fail to figure it out on their own. Invite a volunteer to the board and give the class a number to subtract 10 from. Give the class exactly 30 seconds to try and come up with the right answer and ask them to make note of it in their notebooks. Then ask the volunteer at the board to write the number on the board and keep writing the numbers backward until they have written ten, thereby finding the number ten steps down. So, for example, if the original number was 367, the pupil at the board would write; 366, 365, 364, 363, 362, 361, 360, 359, 358, 357. It would then become clear that the correct answer is 357. Do this until the whole class is getting the answer right. If some pupils are struggling, ask them to work in pairs with pupils who are not struggling. Once they are up to speed, introduce a number like 205. Give them a minute to try to find the answer before having the volunteer try it on the board. Explain that the value of the hundreds also changes because the value of the tens cannot go lower than 0. Also try a number like 103 that will turn into a 2-digit number.

1.2
viii
xii

Activity 5
10 minutes

Write a group of 10 numbers on the board, all 3-digit, and ask the pupils to spot the biggest and the smallest. Repeat these 3 times with different sets of numbers, then tell them, that instead of only identifying the biggest and the smallest, they need to arrange the numbers in ascending order. Explain that this means from smallest to biggest. Then give them a fresh set and ask them to now arrange these numbers in descending order; meaning from biggest to smallest. Do this a few more times so that they can get the hang of it, alternating between descending and ascending. In the last set, slip in the number 1000. Most pupils will probably realise that it is the largest number given the fact that it has four digits. If none of them ask about it, ask them if there are any numbers on the board that seem unfamiliar. Once they identify the odd one out ask them if they can guess what number comes before 1000. If they do not immediately guess 999, refer to the Let's Pause on page 18. Explain that 1000 is the first 4-digit number.

Let's try it

Give pupils five sets of five 3-digit numbers on the board and ask the pupil to arrange the sets in ascending and descending order. They should do this individually at their desks, and then swap work so that they can peer review. Instead of giving them the right answers for the review, tell them they can volunteer to write the correct answer on the board. If they do not volunteer, do not force them.

Let's Pause

If pupils are having trouble write the 4-digit numbers, meaning that they do not realise that there are larger numbers than three-digit number, they may need to revise place value.

1.2
ix
x
xi

Activity 6 15 min

This pairs with Math Lab page 21

This activity is best done outdoors. Bring two kinds of balls to class. Half of the balls should be small, and the rest should be slightly larger. You use table tennis balls and cricket balls. Tell the pupils that the smaller balls are tens, and that the larger balls are hundreds. Then ask them to pair up, and give each pair a basket. Take the class into an open area and ask them to form a circle. Tell them that the goal is to get as many balls into their baskets as possible, so that if they add all the tens and hundreds together, they get a large number. When you say go, they can break out of the circle and start grabbing balls. However, they need to make sure to keep their baskets with them so that they don't get confused for someone else's, and they also should try to stay close to their partner so that they can both put balls in the basket. When you say go, start rolling the balls on the ground in every direction. There should be many more balls than pupils. Make it clear before hand that they are not allowed to snatch each other's balls, and any pushing or shoving will lead to disqualification. Once all the balls have been picked up, ask them to stop and count. Remind them that the larger balls are equivalent to 100 and that the smaller balls are equivalent to 10. Ask them to compare totals and assign themselves ranks using ordinal numbers. If anyone has a total higher than 1000 then tell them they should stop counting and just declare their total as 1000.

Refer to If they are struggling	Confusion level	1 – Does not understand any concept	2 – Does not understand most of the concepts	3 – Understands some concepts but has questions	4 – Understands all the concepts, just needs more practice	5 – Feels confident solving questions	If pupil is below 3 use Math Lab
	Number of Pupils						

Let's talk Math

Ask pupils if they think it is important to have the numbers go so high. What would they need to count that would need such large numbers? When they come up with some examples, ask them, as a creative exercise to try to come up with a way to count a large quantity of objects only with numbers up to 100. They may suggest that you could say, if you were trying to count 400 objects, that there were four hundreds. Point out that four hundreds is quite close to four hundred. Show pupils that although it can seem like there are so many numbers to remember, once they know how to count to hundred, the rest are quite easy to remember. Then ask them if they enjoyed working with number patterns. Did they find them useful? Were they complicated or easy? Point out that once they are confident with number patterns, addition would become much easier. For example, $70 + 68$ is a sum that would require a lot of working, but using number patterns, one can figure out that adding 60 to 70 is just 70, 80, 90, 100, 110, 120, 130, and then by adding the 8 after, you get 138. The same can be done with subtraction. Let them discuss this for five minutes.

Let's get practical

For this activity, try to take the class outdoors. Tell them that you are playing a game of tag. Set a small number of pupils, relative to the size of the class as the chasers and tell the rest of them that their job is to run away. Then explain that all the chasers are going to be tens, and the runners will be hundreds. Each time a hundred is tagged by a ten, it will go up by ten. So, if a runner is tagged 5 times, he or she will be a hundred and fifty. The first to get to 200 loses. When a runner is tagged, they must freeze on the spot until they are able to calculate their new value. Nobody can tag a runner while they are frozen. Allow the class to play for a while to increase their comfort with counting in tens.

Self Assessment

1.1. Ordinal Numbers

1.2. Numbers up to 100

Refer to If they are struggling	Confusion level	1 – Does not understand any concept	2 – Does not understand most of the concepts	3 – Understands some concepts but has questions	4 – Understands all the concepts, just needs more practice	5 – Feels confident solving questions	If pupil is below 3 use Math Lab
	Number of Pupils						

Multiple Choice Questions

Read out the questions or write them on the board. You may ask pupils to either write the correct answer on a white board and hold it up or call out the options one by one, asking them to raise their hands to show which one they have chosen.

- 1) With the number 639 which digit is in the place of the tens?
 - a) 6
 - b) 3
 - c) 9
- 2) If the following numbers were arranged in ascending order, which one would be third? (Write the following on the board 293, 782, 28, 901, 499, and 500)
 - a) 28
 - b) 499
 - c) 500
 - d) 901
- 3) Which of the following is incorrectly arranged in descending order?
 - a) 1000, 499, 387, 199, 201, 64
 - b) 999, 800, 785, 774, 200, 55
 - c) 750, 625, 624, 599, 407, 200
 - d) 279, 272, 234, 219, 209, 200

Unit 2

Number Operations

2.1 Addition of 2-digit numbers (with carrying)

- i. Add ones and ones.
- ii. Add ones and 2-digit numbers with carrying.
- iii. Add 2-digit numbers and 2-digit numbers with carrying.
- iv. Solve real-life number stories, involving addition of 2-digit numbers with carrying.

2.2. Addition of 3-digit numbers (without carrying)

- i. Add 3-digit numbers and ones without carrying.
- ii. Add 3-digit numbers and 2-digit numbers without carrying.
- iii. Add 3-digit numbers and 3-digit numbers without carrying.
- iv. Solve real-life numbers stories involving addition of 3-digit numbers without carrying.

2.3. Addition of 3-digit numbers (with carrying)

- i. Add 3-digit numbers and 1-digit number with carrying of tens and hundreds.
- ii. Add 3-digit numbers

and 2-digit numbers with carrying of tens and hundreds.

- iii. Add 3-digit numbers with 3-digit numbers with carrying of tens and hundreds.
- iv. Solve real-life number stories involving addition of 3-digit numbers with carrying of tens and hundreds.

2.4. Subtraction of 2-digit numbers (with borrowing)

- i. Subtract 1-digit numbers from 2-digit numbers with borrowing.
- ii. Subtract 2-digit numbers from 2-digit numbers with borrowing.
- iii. Solve real-life number stories of subtraction of 2-digit numbers with borrowing.

2.5. Subtraction of 3-digit numbers (without borrowing)

- i. Subtract 1-digit from 3-digit numbers without borrowing.
- ii. Subtract 2-digit numbers from 3-digit numbers without borrowing.
- iii. Subtract 3-digit numbers

from 3-digit numbers without borrowing.

- iv. Solve real-life number stories of subtraction up to 3 digits without borrowing.

2.6. Subtraction of 3-digit numbers (with borrowing)

- i. Subtract 1-digit number from 3-digit number with borrowing.
- ii. Subtract 2-digit number from 3-digit number with borrowing.
- iii. Subtract 3-digit number from 3-digit number with borrowing.
- iv. Solve real-life number stories of subtraction up to 3 digits with borrowing.
- v. Analyse simple situations identifying correct operation of addition and subtraction with carrying/borrowing in mixed form.

2.7. Multiplication

- i. Recognise multiplication as repeated addition (e.g. $2 + 2 + 2 = 6$ is equivalent to 3 times $2 = 6$ and $3 \times 2 = 6$) and use multiplication symbol "x".

- ii. Complete number sequences in steps of 2, 3, 4, 5 and 10 (e.g. in steps of 2 the sequence is expressed as 2, 4, 6...).
- iii. Develop multiplication tables of 2, 3, 4, 5 and 10 till the multiplication of 10×10 .
- iv. Multiply numbers within multiplication table.
- v. Write number sentence for multiplication from the picture such as $2 \times \square = 6$.

- vi. Solve number stories on multiplication up to 1-digit numbers.

2.8. Division

- i. Recognise and use division symbols \div .
- ii. Recognise division as successive subtraction.
- iii. Divide numbers within the multiplication tables with remainder zero.
- iv. Solve number stories

involving division up to 1-digit numbers.

2.9. Addition, Subtraction, Multiplication and Division

- i. Solve real-life situations (using Pakistani currency as well) involving addition, subtraction, multiplication, and division.
Give reasons for choosing the correct operation.

Plan Ahead:

- 2.1 Addition of 2-digit numbers (with carrying)
- 2.2 Addition of 3-digit numbers (without carrying)
- 2.3 Addition of 3-digit numbers (with carrying)
- 2.4 Subtraction of 2-digit numbers (with borrowing)
- 2.5 Subtraction of 3-digit numbers (without borrowing)
- 2.6 Subtraction of 3-digit numbers (with borrowing)
- 2.7 Multiplication
- 2.8 Division
- 2.9 Addition, Subtraction, Multiplication and Division

Allocate realistic time frame/number of periods to teach each topic as per requirement.

Before You Start:

The class should be comfortable with the idea of addition and subtraction, but not at all with carrying and borrowing. It is important that they are aware of place value, so that they are able to understand the number operations in this unit. Having just learnt about number patterns will help them understand the similarities between addition and multiplication, which then in turn will help them with division.

Watch Out For:

While pupils have no prior knowledge of multiplication and division, what they have learnt previously should serve as an excellent foundation. They might be intimidated by the idea of a foreign concept, but introducing it slowly, and allowing them to wrap their heads around it should help them develop their skills and ideas.

This Pairs with:

Math Lab 2, page 23 to 49.

Make Sure You Have:

Chalk or tape	Assorted object
Bowl	Picture sheets
Chits	Posters
Blocks	Counters

If They are Struggling:

A bit of revision of place value should go a long way, if pupils are having trouble with carrying and borrowing. As will plenty of extra practice. Solving sums on the board, while asking the class to help, many times, even after most of the class seems comfortable is almost necessary. Given that many new concepts are introduced in the unit, it would be wise to move slowly through anything that is new. When you see the confusion bar, take note of how many pupils fall under each level. If pupils are at a level 3 or below, have them solve the equivalent Math Lab pages in pairs, having weaker students work with more confident students. First do allow the class to collectively ask questions. If all pupils are at a 4 or above, move on to the next activity.

Let's Begin

Previously pupils have learnt simpler number operations. Ask them if they ever had a hard time adding or subtracting, and if they think they are good at it. If they say they are, ask them if they think they could be better, and if they say they are not, ask them how they think they could improve. After they have answered, ask the class to add 20 and 20. Then ask them to add 50 and 10. Then, ask them to add 26 and 38. Point out that with the third sum, although the numbers were smaller, it is a little bit trickier to calculate, because here the addition involves carrying. Instead of giving them this reason, simply say that it is a hard question, and that you can teach them a math trick to make it much easier. Mention that you have one for subtraction as well. Ask pupils to tell you what they personally find challenging about number operations, and if they have any tricks, mental or on paper, that they could share with the class.

Activity 1

20 min

This pairs with Math Lab page 23

Tell pupils that you are doing an addition activity. Write sums on the board but use the children as counters to solve them, by having them make groups at the front of the class. So, for instance, if the sum is $3 + 5$, then three children will go in one group, and five will go in the other. The rest of the class will then have to figure out what the total will be when the group is combined. The first three times only use single digit numbers. And as they add the groups together, make note of the working on the board, like so:

$$\begin{array}{r} 3 \\ + 5 \\ \hline 8 \end{array}$$

After three sums of one-digit numbers have been done, add a single digit and a double-digit number that involve carrying. For example, 13 plus 8. Make your group of 13 and 8, and then ask the class to help you. Tell them because 13 is a two-digit number, it should demonstrate place value. Arrange the pupils into two lines, one of three and a one of ten. Then explain that the line of 8 is not divided because it is a single-digit number. Explain to the pupils that when adding, one must go by place value. Ask the class to help you as you do this. Follow along on the board as you add the 3 and the 8. As the pupils will know, the answer will be 11. Then point out that since 11 will clearly not fit in the one place the 1 will carry over to the tens. Show this on the board by adding one to the tens but show this practically by moving ten of the pupils from the group of 11 to the group of 10. Make sure they understand that the reason you moved 10 and not 1 is that the one that carried was in the tens. At this point the board will look like this:

$$\begin{array}{r} +1 \\ 13 \\ + 8 \\ \hline 21 \end{array}$$

Repeat this up to three times with one single-digit and one double-digit number in each sum, and then three times with only double-digit numbers.

**Let's
Pause**

Point out to pupils that even though these are larger numbers, they can still count on their fingers if they need to when they add by place value.

Activity 2

10 min

Give the pupils a couple of examples of number stories that include carrying and ask them to help you solve them on the board. Only add 2-digit numbers. Then ask them to make up their own number stories based on real-life experiences. The only rules are that they must include double digits and carrying. As they come up with them, they may present their stories to the class, and the class will make note of the sum. So if the number story is, "Zoha invited 15 people to her birthday party. Her twin brother, Zain invited 17. How many people are coming to the birthday party in total?", the pupils should write:

$$\begin{array}{r} +1 \\ 15 \\ + 17 \\ \hline 32 \end{array}$$

Give them 7 minutes to present as many number stories as possible.

Let's try it

Ask pupils to solve all the sums they wrote down during the activity, and peer review.

Assign 20 minutes of textbook questions. Ask pupils to solve the first five minutes in class, and the other fifteen as homework. Make sure that the five minutes solved in class are questions of varying difficulty, so any pupils who are having difficulty can be identified in the class.

This pairs with Math Lab page 23

This activity is best done outdoors. Using chalk, or tape create three parallel number lines on the ground, as shown below:

0	1	2	3	4	5	6	7	8	9
0	1	2	3	4	5	6	7	8	9
0	1	2	3	4	5	6	7	8	9

Explain each line shows one place value, so the left most will portray the hundreds, the middle one the tens, and the right most, the ones. Tell pupils to use this number line to solve the following questions.

- | | | |
|---------------|-----------------|-----------------|
| 1) $300 + 7$ | 6) $212 + 14$ | 11) $350 + 110$ |
| 2) $450 + 5$ | 7) $720 + 29$ | 12) $100 + 120$ |
| 3) $320 + 9$ | 8) $540 + 25$ | 13) $820 + 100$ |
| 4) $950 + 2$ | 9) $101 + 80$ | 14) $621 + 241$ |
| 5) $466 + 11$ | 10) $300 + 600$ | 15) $356 + 223$ |

Have three pupils volunteer to act as markers on the number line and ask the other pupils to help them figure out how to move. Tell them that they should go one place value at a time, always going from left to right. For instance, to solve $350 + 110$, they should start on 3, 5, 0, respectively. To work out the sum, the pupil on 0 will stay put, the 5 will move up one, and then the three will also move up one. Once the question bank has been solved, present pupils with up to 5 number stories that they must solve using the number lines. Make sure that they number stories involve three-digit numbers and no carrying.

Here are some examples of number stories you can tell:

- Lyla goes to a school with 350 children, and her brother goes to a school with 400 children. How many total pupils in both schools?
- Hassan needs to buy a book for Rs 230. At the store, he remembers he also needs a notepad which costs Rs 225. How much will he pay if he buys both?
- There are two flights landing at the airport at 6 o'clock. One has 115 passengers, and one has 164. How many passengers in total will land at 6 o'clock.
- Kamran is planning his wedding. He has 140 family members and friends that he would like to invite, while his wife has 210. How many wedding invitations will Kamran need to have made?
- Farah is writing a book. She has already written 620 pages but is planning to write 350 more. How many pages will her book have in total?

Assign 15 minutes of classwork from the textbook for pupils to practice.

2.2

i
ii
iii
iv

Activity 3

30 min

2.3
i
ii
iii
iv

Activity 4
15 min

This pairs with Math Lab pages 24 and 25

Solve the following questions in front of the class. Explain that you will be using counters to represent each place value. For example:

Hundreds	Tens	Ones	H T O
○○	○○○	○○○ ○○○ ○○○	2 6 9
		○○○ ○○○ ○○○	+ 9
+		○○○ ○○○ ○○○	<u>2 7 8</u>
○○	○○○ ○○○	○○○○○ ○○○○○ ○○○○○ ○○○	
○○	○○○○○ ○○○	○○○ ○○○○○	

- | | | |
|------------|-------------|--------------|
| 1) 304 + 7 | 4) 260 + 62 | 7) 372 + 422 |
| 2) 798 + 7 | 5) 535 + 82 | 8) 103 + 399 |

As we can see with the counters, the ones column initially had eighteen, but since there can only be one digit in each place value, we removed ten counters from the ones, and added one to the tens. Repeat this so that the pupils understand why ten counters in the ones column are equal to one in the tens column. Solve the rest of the questions on the board, showing carrying, while also showing the answers with the counters.

Let's try it

Read out up to ten number stories to the class, involving carrying, and ask pupils to solve them individually at their desks. They should show their working.

Some examples of number stories you can use are as follows:

- 1) Amna is helping her mother make cupcakes to sell at a funfair. They have made 366, but they still have enough ingredients left for 145 more. Amna's mother decides to use all the ingredients. How many cupcakes will they eventually have at the fair?
- 2) Rabia is raising awareness about the environment. She asks volunteers to help her plant trees in a forest that only has 126 trees left. After a week of hard work, Rabia and her volunteers have planted 399 trees. How many trees does the forest have now?
- 3) Jehanzeb has saved Rs 450 when his grandfather gives him a jar full of change. After he counts the change in the jar, he finds it has Rs 288. How much money does Jehanzeb have now?

2.4
i
ii
iii

Activity 5
15 min

Ask pupils if they think that using place value made it easier to add large numbers. If they say yes, ask if they think it would also help with subtraction. Bring up carrying and ask pupils if they can come up with a similar way to subtract numbers on paper. Show them how to solve the first four following, using carrying on the board:

- | | |
|------------|-------------|
| 1) 15 - 9 | 6) 52 - 48 |
| 2) 23 - 15 | 7) 93 - 37 |
| 3) 76 - 49 | 8) 57 - 9 |
| 4) 81 - 39 | 9) 42 - 34 |
| 5) 27 - 19 | 10) 66 - 59 |

Give them 20 counters each and ask them to solve the rest preferably in groups, using the counters if they need to.

Let's try it

Ask the pupils to solve the following individually:

- 1) If there are 18 people on a bus and 9 get off, how many are left?
- 2) Ifrah buys 36 balloons, but 8 pop in the car. How many does she have when she gets home?
- 3) Somaiya makes 55 brownies for a party, but only 37 get eaten. How many are left?
- 4) Malik is selling 52 pencils at his store. During the week, 17 are bought. How many pencils does he have left at the end of the week?
- 5) A company orders 75 paper cups a day for their employees. They notice that at the end of the day there are always 16 left over. How many paper cups get used at the company every day?

Assign 15 minutes of classwork from the textbook for the pupils to practice borrowing.

This pairs with Math Lab page 23

This activity is very similar to activity 3, except the pupils will be learning subtraction without borrowing. Ask three pupils to volunteer as counters, and make a number line, like so:

0	1	2	3	4	5	6	7	8	9
0	1	2	3	4	5	6	7	8	9
0	1	2	3	4	5	6	7	8	9

2.5

- i
- ii
- iii
- iv

Activity 6

20 min

Explain to pupils that just like in activity 3, they will be using the number line to try to solve their subtraction questions by going through the numbers digit by digit. Go through the first three questions with them and have them solve the rest of their own. If there are too many pupils, have multiple number lines. Make sure to do at least fifteen sums, being sure to teach them how to subtract one-digit numbers, two-digit numbers, and three-digit numbers from three-digit numbers. Here are some questions you could use:

- | | | |
|----------------|----------------|-----------------|
| 1) $345 - 5$ | 6) $474 - 104$ | 11) $776 - 70$ |
| 2) $782 - 12$ | 7) $819 - 5$ | 12) $691 - 510$ |
| 3) $470 - 370$ | 8) $273 - 11$ | 13) $289 - 7$ |
| 4) $382 - 1$ | 9) $649 - 318$ | 14) $652 - 31$ |
| 5) $828 - 27$ | 10) $826 - 4$ | 15) $450 - 240$ |

Let's try it

Bring pupils back to class and give them up to ten subtraction number stories that do not involve borrowing. Ask them to solve them individually at their desks. Here are some examples of questions you can use:

- 1) If 360 pupils go to a school and 20 pupils are absent, how many are present?
- 2) Malaika has 850 rupees. She spends 300. How much money does she have now?
- 3) Ansa wrote a 368 page book, but her editor asked her to remove 7 pages. How many pages will she have left?
- 4) There are 886 pupils in a school. 450 are in the junior campus, so how many are there in the senior campus?
- 5) Naima reads the first 56 pages of a 158 page book. How many more pages until she is done?

Refer to If they are struggling	Confusion level	1 – Does not understand any concept	2 – Does not understand most of the concepts	3 – Understands some concepts but has questions	4 – Understands all the concepts, just needs more practice	5 – Feels confident solving questions	If pupil is below 3 use Math Lab
	Number of Pupils						

2.6
i
ii
iii
iv

Activity 7

15 min

This pairs with Math Lab pages 26, to 30, 31

Fill a bowl with chits, that each have a subtraction questions on them. There must be an equal amount of single digit numbers being subtracted from three-digit numbers, two-digit numbers from three-digit numbers, and three-digit numbers from three-digit numbers. They should all require borrowing. After each pupil has picked a chit, give them 2 minutes to think. Tell them they must come up with a number story to match their equation. After the 2 minutes are up, ask each of them to read their number story aloud to the class. The first one to raise their hand with the right answer will get a point. At the end, total the points and name the top three pupils. Here are some examples of equations you can put on the chits:

- | | | |
|--------------|--------------|---------------|
| 1) 864 – 806 | 5) 965 – 789 | 9) 373 – 5 |
| 2) 678 – 9 | 6) 672 – 199 | 10) 754 – 75 |
| 3) 962 – 479 | 7) 574 – 98 | 11) 643 – 478 |
| 4) 852 – 66 | 8) 524 – 8 | 12) 314 – 169 |

2.6
v

Activity 8

20 min

The aim of this activity is for the class to connect addition and subtraction to its real-life applications. Arrange the class in a circle. Tell them that you will be going around the circle and everyone will have to share a real-life example where one would need to use addition or subtraction. However, they must not share whether it is an addition example, or a subtraction example. The rest of the class will have to raise their hands to guess. Remind them that it should not take too long to tell. The way the game will work is that once a pupil has shared an example, and guessed the right answer to another pupil's example, they may leave the circle and start on their homework in class, therefore having less homework at the end of the day. The first child to raise their hand will get to answer, but once a pupil has gotten one right, they can't attempt anymore. Start by giving them an example of a question from your life. Here's an example of what it should be like; "If my water bottle had 500 ml of water in it at the start of the day, and 200 ml at the end of the day, how can I figure out how much water I drank?" The correct answer to this would be to subtract 200 from 500.

Assign 15 minutes of homework from textbook. Some may be done in class as per above activity.

2.7
i

Activity 9

15 min

This pairs with Math Lab pages 29 to 31

Draw the multiplication sign “ \times ” on the board and ask the class if they know what multiplication is. Let them discuss what they might know about it for a couple of moments, and then explain the concept of multiplying. Using 2×2 , explain that this simply means two twos, meaning what number do two twos result in when you add them together. Link this to addition explaining that while 2×2 is equivalent to $2 + 2$, 2×3 is equivalent to $2 + 2 + 2$. Tell them at this point that, as a rule, in multiplication, it does not make a difference to the answer if you switch the first and second number. So 4×2 is the same as 2×4 . Demonstrate this by writing $4 + 4$ and $2 + 2 + 2 + 2$ on the board and asking the class to solve both.

Then divide the class into two groups, and give one group the following to solve:

6×2	5×3	3×6
4×2	6×4	6×5

Then give the other group of the class these (inverted versions of the same).

2×6	3×5	6×3
2×4	4×6	5×6

Allow them to compare answers so they can be assured that there is no difference.

2.7
ii
iii
iv

Activity 10

30 min

Assign 5 children to each of the following numbers; 3, 4, 5, 10. If the class has fewer than twenty pupils some of them will have to do more than one number. Explain the concept of the number sequences using 2 as an example. Write the two times on the board with answers, and go through the answers, pointing out that the pattern in the number sequence is simply to move up two numbers every time, or rather, to just add two. Ask the class to copy the multiplication table for two. Relate multiplication tables to the patterns they learnt in previous classes with shapes. Once they have grasped the concept, invite the five pupils assigned to the number 3. Present them with a bowl of chits. This bowl will contain ten chits that will have multiples of three starting from 3 all the way to 30. Since there are only 5 pupils, only 5 chits will be picked out. The pupils will then have to arrange themselves in ascending order, and with the help of the rest of the class identify the missing numbers, and where they are missing from. Furthermore, each pupil will have to figure out on their own where they fall on the times table. Help them do this by writing what they figure out on the board. Make note of all the numbers present, and what 3 was multiplied by to get them. This will help the class find the missing pieces. Repeat this activity with 4, 5, and 10 spending no more than 6 minutes on each number.

Let's try it

Ask pupils to write down multiplication tables for 3, 4, 5, and 10, after putting the complete table for 2 on the board as an example (which they should copy down). If they get stuck, or are unable to remember, they need only use what they learnt in activity 9 to figure out what the answers are. Each table up to 10. Give pupils no more than 7 minutes for each table. Once they are written, ask pupils to go over them as homework so that they are more comfortable with them, and can use them as a point of reference to solve multiplication questions.

2.7
v
vi

Activity 11

6 min

Present the pupils with an assorted variety of objects. Place them at the front of the class and show them how to write a multiplication sentence. So, for example, if there are 15 objects, pupils could write $3 \times 5 = 15$. Rearrange the objects three times, making sure the total number of objects is always a multiple from one of the tables already learnt. Ask them each time to come up with as many multiplication sentences as possible, for example 12 would have 2×6 , 3×4 , 4×3 , and 6×2 . Divide the class in two more groups and hand out sheets showing pictures of objects or use a textbook or story book. Make sure that both groups get different material. Ask pupils to make multiplication sentences for the pictures but to leave them incomplete by replacing a number with a question mark, like so $3 \times ? = 6$. After they have done, ask each pupil to swap their work with a pupil in the other group so they can fill in the blanks in each other's work.

Let's try it

Ask pupils to solve up to ten multiplication stories as individual classwork. Here are some examples of stories you could use:

- 1) If Sophie's two cats had three kittens each, how many kittens are there?
- 2) Asha is having a party, and her mother says there must be three pieces of candy for every child at the party. If the total number of children at the party is 8, how many pieces of candy should Asha's mother have ready?
- 3) Mikyle stops at a store to buy himself some gum that costs Rs 5. Before he buys it, he decides he should buy some extra gum to share with his family. How much will it cost him to buy 5 pieces of gum?
- 4) A teacher needs 4 printouts for each of her pupils. If she has 10 pupils in her class, how many printouts should she get?
- 5) Ali has 5 uncles, and they each have 3 children. How many cousins does Ali have?

2.8

i

ii

iii

Activity 12

10 min

Put pupils in pairs, and using building blocks, ask each pupil to arrange a building of 8 blocks. Draw the division symbol on the board and explain that it represents division. Then write on the board $8 \div 2$. Stop here and ask them what they think this means. Remind them to think of the meaning of the word divide. As they volunteer their answers, tell each pair that their buildings are made of 8 blocks, so what would it mean if you asked them to divide the building by two? Most pupils here might realise that this would mean to separate the blocks into 2 piles, but if not, explain the meaning of the word divide, and explain that divide by two simply means to divide into 2 equally. Once they understand this, show that by physically dividing the blocks into two piles, one can come to the answer by counting the blocks in each pile. Repeat at this point that the way to solve an equation that looks like this $8 \div 2$ is to break the first number into as many equal parts as the second number, and the answer would be how many parts there are. Solve on the board $8 \div 4$, and $8 \div 1$ so that the pupils can follow along with their blocks. Then write on the board $20 \div 5$. Point out that this is not a question that could be solved with blocks because the numbers are too large. Ask pupils if they can think of a way they could do division without physical objects. Give them a moment to think and ask them if they think they could use subtraction. Lead them to the conclusion that if they continually subtract 5 from 20 until they eventually get 0, they can simply count the number of times they subtracted it and come to the answer. Try this on the board three more times with numbers divisible by 3 and 4.

Let's try it

Ask the pupils to solve up to ten division questions in pairs and to ask for guidance if they need it. The numbers should all be from within the multiplication tables of 2, 3, 4, 5, 10. Here are some examples of questions you can give them:

- | | | | |
|-----------------|------------------|-----------------|------------------|
| 1) $6 \div 2$ | 6) $15 \div 5$ | 11) $35 \div 5$ | 16) $45 \div 5$ |
| 2) $8 \div 4$ | 7) $15 \div 3$ | 12) $40 \div 5$ | 17) $18 \div 2$ |
| 3) $10 \div 5$ | 8) $50 \div 5$ | 13) $33 \div 3$ | 18) $14 \div 2$ |
| 4) $9 \div 3$ | 9) $100 \div 10$ | 14) $36 \div 6$ | 19) $80 \div 10$ |
| 5) $60 \div 10$ | 10) $21 \div 3$ | 15) $44 \div 2$ | 20) $24 \div 4$ |

2.8

iv

Activity 13

10 min

Ask the class if they think they could make number stories for division like they made for multiplication. Give them some examples, using words like "how many each" or, how many per" that they would be familiar with, so they get an idea of how much division there is in every day life. Ask them to pair up and to each to come up with their own examples of division in real-life. They should then create their own number story based on their real-life example and challenge their partner to solve it. Clarify at the start that they should only use single-digit numbers.

**Let's
Pause**

Another way to think about a division sentence like $6 \div 3$ is 'how many times do you need to put 3 together to make 6?'. Also point out that since division is the opposite of multiplication, pupils can check their answers with the multiplication tables. So $25 \div 5 = 5$ can be rearranged into $5 \times 5 = 25$.

2.9
i

Activity 14

15 min

Hand out sticky notes in 4 different colours making sure each pupil gets one of each colour. Explain that each colour represents a number operation (addition, subtraction, multiplication, division), and have them write the symbol for every operation on its corresponding post it. Make sure they know they all must follow the same colour system and may not make up their own. Explain that you will be reading out a real-life situation, kind of like a number story, but it will be up to them to decide which number operation they need to solve the problem. Tell them you will read out the question twice, count to three, and then everyone must vote by holding up the right post it. The different colours will make it easier to see who is voting for what. Remind them that they must not shout out their answers but wait for a chance to put up their sticky notes. Here are some examples of real-life situations:

- 1) Ayla has 20 chocolate bars and wants to share them equally between her 5 friends. How many will each friend get? (Divide)
- 2) Laila is hosting a dinner and wants to make sure there are 3 slices of pizza for each guest. How many slices should there be 6 guests? (Multiply)
- 3) Ali is making scrambled eggs for his family. He always uses 2 eggs per person. If he is using 8 eggs, how many people is he cooking for? (Divide)
- 4) Saira bought 18 apples but 6 were damaged as she brought them home. How many apples are still perfect? (Subtract)
- 5) Zeba ordered 22 new pens. After this, her total number of pens is 35. How many pens did she have previously? (Subtract)
- 6) If you go shopping at a store where everything costs Rs 10, how many objects can you buy with 80 rupees? (Divide)
- 7) If you go shopping at a store where everything costs Rs 10 and buy 6 things, how much will you pay? (Multiply)
- 8) Misha made 2 cups of tea for each of her guests, and afterward, there were 18 dirty teacups. How many guests were there? (Divide)
- 9) Aleesa has invited 6 of her friends and 3 of her cousins to her birthday party. How many people has she invited? (Addition)
- 10) Ali invites his friends to play cricket in the park. Out of the 25 people he invited, 18 are coming. How many people were not able to come?

At the end of this activity, have a quick class discussion, touching on each of the questions and ask pupils what their reasoning was for making the choices they did.

Let's talk Math

Ask pupils if they think it is important to have the numbers go so high. What would they need to count that would need such large numbers? When they come up with some examples, ask them, as a creative exercise to try to come up with a way to count a large quantity of objects with numbers only up to 100. They may suggest that you could say, if you were trying to count 400 objects, that there were four hundreds. At this point you should point out that four hundreds is quite close to four-hundred. Use this to show pupils that although it can seem like there are so many numbers to remember, once they know how to count to a hundred, the rest is quite easy to remember. Then ask them if they enjoyed working with number patterns. Did they find them useful? Were they complicated or easy? Point out that once they are confident with number patterns, addition would become much easier. For example, $70 + 68$ is a sum that would require a lot of working, but using number patterns, one can figure out that adding 60 to 70 is just 70, 80, 90, 100, 110, 120, 130, and then by adding the 8 after, you get 138. The same can be done with subtraction. Let them discuss this for 5 minutes.

Let's get practical

For this activity, try to take the class outdoors. Tell them that you are playing a game of catch. Set a small number of pupils, relative to the size of the class as the chasers and tell the rest of them that their job is to run away. Then explain that all the chasers are going to be tens, and the runners will be hundreds. Each time a hundred is tagged by a ten, it will go up by ten. So, if a runner is tagged 5 times, it will be a hundred and fifty. The first to get to 200 loses. The game will be, the runners run, and the chasers need to tag them. When a runner is tagged, they must freeze on the spot until they are able to calculate their new value and announce it. Nobody can tag a runner while they are frozen. Allow the class to do this for a while to increase their comfort with counting in tens.

Self Assessment

- 2.1. Addition of 2-digit numbers (with carrying)
- 2.2. Addition of 3-digit numbers (without carrying)
- 2.3. Addition of 3- digit numbers (with carrying)
- 2.4. Subtraction of 2-digit numbers (with borrowing)
- 2.5. Subtraction of 3-digit numbers (without borrowing)
- 2.6. Subtraction of 3-digit numbers (with borrowing)
- 2.7. Multiplication
- 2.8. Division
- 2.9. Addition, Subtraction, Multiplication, and Division

Refer to If they are struggling	Confusion level	1 – Does not understand any concept	2 – Does not understand most of the concepts	3 – Understands some concepts but has questions	4 – Understands all the concepts, just needs more practice	5 – Feels confident solving questions	If pupil is below 3 use Math Lab
	Number of Pupils						

Multiple Choice Questions

Read out the questions or write them on the board. You may ask pupils to either write the correct answer on a white board and hold it up or call out the options one by one, asking them to raise their hands to show which one they have chosen.

1) Calculate the following: $26 + 33$.

- a) 69
- b) 59
- c) 70
- d) 50

2) Calculate the following: 25×3

- a) 75
- b) 65
- c) 80
- d) 100

3) Calculate the following: $81 \div 9$.

- a) 9
- b) 10
- c) 12
- d) 7

Unit 3

Fractions

3.1 Fractions

- i. Recognise fractions as equal parts of a whole
- ii. Identify half, one third and quarter with the help of objects and figures (without writing $\frac{1}{2}$, $\frac{1}{3}$, $\frac{1}{4}$).
- iii. Represent half, one third and quarter in numerical form ($\frac{1}{2}$, $\frac{1}{3}$ and, $\frac{1}{4}$).
- iv. Shade the equal parts of a given figure to match a given fraction.
- v. Recognise and name unit fractions up to $\frac{1}{10}$.
- vi. Recognise fractions like two thirds ($\frac{2}{3}$), three fourths ($\frac{3}{4}$), four fifths ($\frac{4}{5}$), up to nine tenths ($\frac{9}{10}$).

Plan Ahead:

3.1 Fractions

Allocate realistic time frame/number of periods to teach each topic as per requirement.

Before You Start:

The class should have a good understanding of what half and quarter mean, and since they are already familiar with division, they will be able to understand the concept of dividing something into equal parts.

Watch Out For:

Use one shape at a time, but the same fraction must be demonstrated with different shapes, so that children see a fraction associated with any shape or any set of objects. This is so that pupils understand that fractions can apply to anything that has equal parts.

This Pairs with:

Math Lab 2 pages 42 to 62.

Make Sure You Have:

Chart paper A4 sheet
Assorted fruit Oranges

If They are Struggling:

To help them grasp the idea, associate the fractions with fraction names.

2 equal parts: 2 halves in a whole

3 equal parts: 3 thirds in a whole

4 equal parts: 4 quarters in a whole

10 equal parts: 10 tenths in a whole

When you see the confusion bar, take note of how many pupils fall under each level. If pupils are at a level 3 or below, have them solve the equivalent Math Lab pages in pairs, having weaker students work with more confident students. First do allow the class to collectively ask questions. If all pupils are at level 4 or above, move on to the next activity.

Let's Begin

Begin with a recapitulation of fractions, using a story and build up more stories on the rest of the fractions. For example, mamma bear spread some chocolate sauce over a crusty pie cut in quarters. She put it on one quarter for baby bear, one for papa bear and one for her own share. How many quarters did she put the sauce on? How many quarters did not have any chocolate sauce? Of course, at this point you won't say "three over four" but continue to refer to the fractions in different ways. The answer is three quarters or $\frac{3}{4}$; and one-quarter or $\frac{1}{4}$. One could even say 3 out of the four pieces. Explain that this could also be used to refer to four separate balls, if those balls were being looked at as a whole, and that counting like this, in portions is called fractions. The definition of the word is a small or tiny part, amount, or proportion of something.

SLOs

3.1

i

ii

iii

Activity 1

15 min

This pairs with Math Lab pages 42 to 44

Place three oranges or any available object that can be easily cut into half and quarter in front of the class and ask them to count them. Then take away two and ask them to count again. After they count one, cut it in half and remove one half so that there is only half an orange. Then ask them to count the oranges. Some might say half or one. Point out that there is half of one orange, so one is the wrong answer. Take out two more oranges and cut one into three pieces and one into four. Explain that while the piece of the first orange is referred to as a half, a piece of the second one is referred to as a third of an orange. Let them guess what the last one is referred to. Some of them might know the word quarter, but some might guess fourth. Let them know that both are technically correct. A quarter is generally one of four pieces. Highlight the fact that all the pieces need to be equal for these labels to apply. Write the word half on the board and ask the class if they know what the number for half is. Let them guess and eventually write $\frac{1}{2}$ on the board. Explain that numbers written like this are called fractions and are used for numbers that are not whole. Point out that the orange is one out of two, because it is one of two pieces. Ask them if they can guess how to write a third or a fourth. Let them come to the board to write their best guesses.

Let's try it

Give pupils a worksheet or have them copy off the board. Write $1, \frac{1}{2}, \frac{1}{3},$ and $\frac{1}{4}$ on one side, and draw four circles on the other. Colour them in according to the fractions and colouring one completely so that the pupils can match the numbers to the circles.

3.1
ii

Activity 2
12 min

This pairs with Math Lab pages 45 to 49

If possible, arrange the class in a circle for this activity. Hand everyone an A4 sheet. Tell the pupil they should each fold their paper to show the fraction $\frac{1}{2}$. Remind them that the direction in which they fold is not important so long as both sides are equal. Ask them to hold up their paper when they are done. Point out that whether the paper is folded lengthwise or laterally, both are right as the paper is still equal on both sides. Then ask them to fold the paper according to $\frac{1}{3}$. Once more, point out that the direction of the folding is irrelevant. Lastly, ask them to do $\frac{1}{4}$. Use this opportunity to point out that a quarter is a half of a half.

Assign 15 minutes of classwork from the textbook relating to fractions.

Refer to If they are struggling	Confusion level	1 – Does not understand any concept	2 – Does not understand most of the concepts	3 – Understands some concepts but has questions	4 – Understands all the concepts, just needs more practice	5 – Feels confident solving questions	If pupil is below 3 use Math Lab
	Number of Pupils						

3.1
iv
v
vi

Activity 3
10 min

This pairs with Math Lab page 50

Write the following fractions on the board; $\frac{1}{2}, \frac{1}{3}, \frac{1}{4} \dots \frac{1}{10}$. Ask pupils to read them out and tell them that they can be said as one over six, or one sixth, or even sometimes as a sixth. Then point out that $\frac{2}{3}$ is also a fraction. Invite a volunteer to the board to draw what they see as $\frac{2}{3}$. This could be done by drawing a square or a circle and shading it. Once this is done, ask pupils what other fractions they can think of that have 2, 3, 4, 5, 6, 7, 8, 9, 10 in the denominator. Give them 5 minutes to write down as many as they can think of, including the ones on the board, reminding them that the top number should not be bigger than, or equal to the denominator. If they are able to write down all the numbers they should have 45 in total. If they have less than 45, have them compare work to try and figure out what they missed.

Let's try it

Give each pupil a circular piece of paper. On the back of each one, there will be a fraction. Ask them to colour a part of the circle to represent the fraction. Remind them that they can fold their circle to make sure all the parts are equal. Give them 5 minutes to do this, and then ask them to show their circle to the pupils seated next to them and have them guess the fraction. The fraction should be one of the 45 previously taught.

Let's Pause

The number at the top of a fraction is referred to as a numerator, and the bottom one is the denominator.

3.1
vi**Activity 4**
10 min

Bring an assortment of fruits to class and place up to ten at a time in front of the class. Then ask questions like, what fraction of the fruit is apples? Change the number of fruits so that the denominator of the fraction changes. Ask different questions; what fraction of the fruit is green, or has seeds, or needs to be peeled before it is eaten?

Let's try it

Ask pupils to draw a representation of any fraction that has a denominator up to ten. Give them an example of a drawing on the board, perhaps a drawing of 5 balloons, 3 pink, and 2 blue. Write under the drawing, $\frac{3}{5}$ of these balloons are blue. Ask them to make a drawing of anything they like, and write a sentence under it, stating what fraction the image is meant to be showing. Encourage them to be creative and think outside the box.

Let's talk Math

Is a fraction a number? Ask pupils this question and allow them to discuss it. What are their reasons for them saying it is? And what are the counter arguments. Ask them to keep in mind that this conversation is a gathering of opinions, not a way to try and determine a correct answer. Everyone is encouraged to speak, even if they are thinking aloud. Pupils should consider that one of the functions of a number is that they can specify a quantity of things, and that is something that a fraction can do as well, but in a different way. Ask them how they would know when to use a number and when to use a fraction. If you asked how many pupils in the class are wearing glasses, which should they use? A number. But if you asked what part of the class is wearing glasses, taking the class as a whole, it could be seen as an opportunity to use a fraction.

Let's get practical

Tell each child that they are in charge of finding 8 "customers", can be within the class, and taking their order for what they would like on their pizza. Here are some options:

Mushroom	Basil	Olives	Onion
Pepperoni	Tomato	Jalapeno	Capsicum

Each person placing orders can choose as many toppings as they like, or they can opt for a plain pizza. Once the pupils have each noted down 8 orders, hand out chart paper. Help everyone draw a circle and put 4 lines through it so that it is divided into 8. Then ask them to start drawing their pizza. Now they must make sure that there is a slice for each customer, so as they draw the pizza, they must be careful of where they draw their toppings. If only two people wanted basil, then there should be basil on only two slices, but those slices need to also have the rest of the ingredients requested with basil. Once they are done, they should list write a fraction for each of the ingredients listed above. If one of them was not used at all, they should just write 0. For the rest, it should be the fraction of the pizza that has the topping, so the number of slices over 8. Have them do this on their own but allow them to ask as many questions as they need. Allow them to cut up their pizza and serve the slices to their customers. If the school were to have access to an oven, this activity could be done in groups with real pizza dough, and with actual toppings instead of drawn on ones.

Self Assessment

3.1. Fractions

Refer to If they are struggling	Confusion level	1 – Does not understand any concept	2 – Does not understand most of the concepts	3 – Understands some concepts but has questions	4 – Understands all the concepts, just needs more practice	5 – Feels confident solving questions	If pupil is below 3 use Math Lab
	Number of Pupils						

Multiple Choice Questions

Read out the questions or write them on the board. You may ask pupils to either write the correct answer on a white board and hold it up or call out the options one by one, asking them to raise their hands to show which one they have chosen.

- 1) Draw the circles below on the board. Which of the following represents $\frac{6}{8}$?

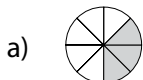

- 2) What is the right fraction to represent the shaded part of this circle? 

a) $\frac{4}{8}$

b) $\frac{2}{4}$

c) $\frac{1}{2}$

d) All of the above

- 3) A quarter of these balls would be how many? (Here, draw 4 balls on the board.)

a) 4

b) 8

c) 2

d) 1

Unit 4

Measurement: Length, Mass, and Capacity

4.1 Length

- i. Compare the lengths of different objects.
- ii. Recognise the units of length (metre and centimetre).
- iii. Use standard metric units of length (metre and centimetre) and their abbreviation to measure and record lengths of variety of objects.
- iv. Use addition and subtraction within 100 to solve real-life situations involving lengths in same units.

4.2 Mass

- i. Compare the mass of different objects.
- ii. Recognise the units of mass, i.e. kilogram, gram.
- iii. Use standard metric units of mass (kilograms and grams) and their abbreviation to measure and record mass of variety of objects.
- iv. Use addition and subtraction within 100 to solve real-life situations involving mass in same units.

4.3 Capacity

- i. Compare capacity of different objects using nonstandard units (jug, glass, cup, etc.).
- ii. Recognise and use the standard metric units of capacity, i.e. litre and millilitre.
- iii. Use addition and subtraction within 100 to solve real-life situations involving capacity in same units.

Plan Ahead:

- 4.1 Length
- 4.2 Mass
- 4.3 Capacity

Allocate realistic time frame/number of periods to teach each topic as per requirement.

Before You Start:

Pupils would have learnt about the concepts of length and mass before, but always with non-standard units. This unit will be their first interaction with the standard units of length and mass in the class. However, they may still know a little bit about them from home.

Watch Out For:

Avoid any confusion between the units to measure mass, length, and capacity. Also, be sure to explain them that while it is almost always alright to use the abbreviations instead of the words, they do have to make sure they learn the correct spelling.

This Pairs with:

Math Lab 1, page 63 to 66

Make Sure You Have:

Chart paper	A4 sheet	Ruler
Balance scales	Oranges	Water
Pupils' toys and books	Assorted fruit	Measuring cups
Digital scales	Metre ruler	Water containers

If They are Struggling:

Try to connect the non-standard units previously learned to what they are learnt now. Explain that these units are agreed upon universally, which is why it is important that everyone learn to use them: but they are still just measurements. The phrase "100 ml of water" is the same as half a cup of water. When using addition and subtraction with these units, make sure they know to treat the numbers just as numbers, because the unit will not affect the math. Also, be sure to assign plenty of classwork from your textbook and workbook so that they are not entirely dependant on the activities, because this unit will require plenty of practice.

When you see the confusion bar, take note of how many pupils fall under each level. If pupils are at a level 3 or below, have them solve the equivalent Math Lab pages in pairs, having weaker students work with more confident students. First do allow the class to collectively ask questions. If all pupils are at level 4 or above, move on to the next activity.

Let's Begin

Ask pupils how they know if an object is heavy or light. They will most likely answer that they can tell by lifting it. Ask them, is that really a good way to check? Let them discuss what could go wrong. If they don't realise themselves, point out that just because one person thinks that something is heavy, it do not necessarily mean that everyone else will, or that it is in fact, heavy. Similarly bring up length, and ask if they can connect that idea to length as well. Lead the pupils to the idea that if you decide whether something is heavy by lifting it, and if it is long by looking at it, you are really deciding if something is heavy for you or looks long to you. While these are valid observations, they are not so good for sharing ideas. A friend may tell you that something is heavy, but you may find it light. A standard way to communicate the mass of an object, or the length or capacity is necessary. Ask pupils if they know of any.

SLOs4.1
i**Activity 1**

5 min

Ask the pupils what they think the longest object in the class is. Challenge their answers and offer more ideas if they are stuck. Then ask what the shortest object is. Make a list on the board of five longest, and the shortest 5. If they are within reach, help the pupils measure them using non-standard units, like hand span to make sure that they are right about which one is longest/shortest.

Let's Pause

Pupils might need a reminder to write the units next to their answer. Remind them that without the unit, they are not really answering the question.

4.1
ii
iii**Activity 2**

10 min

Show the class a metre ruler and ask them to vote whether they think it is long or short. Ask for examples of what they think they could measure with a ruler that big. After they come up with a few, ask the class what they understand by the word 'measure'. Let them do their best to answer, and then ask how they have measured things previously. If they are confused, explain that you are asking about units. Most of them will probably mention using body parts like hand span or arms. Ask at this point if they can see any flaws with using body parts to measure. Let them volunteer ideas, and they will hopefully conclude that using a non-standard unit of measurement, especially a body part, is too inconsistent. If they do not, discuss how we use measurements in real-life. Use the examples of giving measurements to a carpenter. If one said, "build me a wardrobe three hands wide", the carpenter would not be able to get the same measurements using his or her own hands. Compare this to days of the week. Explain that we have standard units of measurement that can be used globally because they are necessary. Tell them about metres and centimetres while passing around the metre ruler so that pupils can get familiar with them. Ask questions like, "can you guess how many centimetres can fit in a metre?".

Let's try it

As homework, ask pupils to trace the outline of one of each of their family compare hands in their notebook. Tell them to be sure to also trace their own hands, and to label them. In compare, ask each pupil to measure each hand in centimetres, using a ruler. Draw your hand on the board and measure it so they know how to do it. Measure from top to bottom, and from side.

Remind them to mark their measurement points so that they can find them again if they need to. Once they know what they are doing, ask them to measure the outlines they got from their families, and compare them. Ask the class if the size of each person's hand was different, or not. Point out that the difference in measurements is why we do not use non-standard units. Measurements must always be precise. Ask the pupils to come up with examples of what could go wrong if people used the wrong measurements.

Let's Pause

If pupils want to measure something that is longer than the measuring tool you have available, show them how to do it. For example, if you have a metre ruler, but an object is longer than a metre, they should measure the metre, put down a mark, or some tape, and then measure from the mark.

4.1
iv**Activity 3**
10 min

Ask pupils, in pairs, to measure five to ten objects around the class or outdoors to get used to the units.

Using the measurements of the hands from the previous Let's Try It, ask the pupils to find differences between the measurements. Have a volunteer share their measurements on the board. Have the class help you to; arrange them from smallest to biggest, calculate the difference between the width and length of each hand and the one bigger than it, also find the difference between the biggest and the smallest. So, if the hands from smallest to biggest are, in order, A, B, C, D, find the difference between A and B, B and C, C and D, and A and D.

Let's try it

Assign up to five measurement-based addition and subtraction questions, within 100 using only one unit in each. Here are some examples you can use:

- 1) Samana has grown 3 centimetres. She is 98 centimetres tall. How tall was she before?
- 2) If a teacup is 8 centimetres tall, but you have to leave the top 2 centimetres empty to avoid spilling. How many centimetres high will the tea be from the bottom of the teacup?
- 3) In a relay race, I run 50 metres and my friend runs 35. How many metres did we run in total?
- 4) A teacher has a roll of tape that is 50 centimetres long. She uses an 18-centimetre-long piece of tape to secure a wire to a wall. How much tape is left in the roll?
- 5) Mahnoor's hair is 25 centimetres long when she decides to cut off 7 centimetres. What will her hair length be after her haircut?

4.2
i**Activity 4**
25 min

Ask every pupil, the day before, to bring in their favourite toy and their favourite book from home. Remind them not to bring anything delicate or valuable. Once they all have a book and a toy, make groups of four to six. If you have group A, B, C, D, and E. Ask each group to compare weights, just by feel and list their books and toys from heaviest to lightest in each group, keeping the book list separate from the toy list. After they have made their lists, combine groups in sets of twos so that there are half as many groups left. If there are an odd number of groups, let one of the groups be of three, so hypothetically you then have A and B in one group, C, D, and E in one group. Ask pupils to work collaboratively with their new group members and create new lists together, once again, listing the entire group's toys and books in order of heaviest to lightest, and once again, keeping the book list separate from the toy list. Remind them that they are going only by feel. Also make sure they don't spend more than 7 minutes making each list. Once the new lists are made, collect them, and introduce the class to balance scales. Give them a quick explanation of how they work, in case they have forgotten, and then explain that you will be using them to create a list for the whole class, on the board, using the balance scales to get a more accurate idea of which book or toy is heavier than the other. At this point you need not use any units; only adjectives like heavy and light. Make pupils help you identify which side of the balance scales is lower.

Refer to If they are struggling	Confusion level	1 – Does not understand any concept	2 – Does not understand most of the concepts	3 – Understands some concepts but has questions	4 – Understands all the concepts, just needs more practice	5 – Feels confident solving questions	If pupil is below 3 use Math Lab
	Number of Pupils						

4.2
ii
iii

Activity 5
25 min

Collect copies of textbooks and/or workbooks from all the pupils' classes. If there are less than five books, borrow some from the school library, but make sure there are no more than five. Try to have as much variation in mass as possible. For this class, try to have as many masses as possible. At minimum a one-kilogram mass, a five-hundred-gram mass, and a one-gram mass are necessary. Introduce these to the class and ask them to pass them around as you explain the activity. Write the words 'kilogram' and 'manual' on the board and explain them in relation to the mass. Ask pupils if they can guess what one would need mass for. How could one make use of an object that they knew the exact mass of? If they standard don't come to an answer, ask them if the mass could be used with the balance scales. Lead them to the conclusion that using standard weights can help one determine the approximate mass of an object, or at least whether it is more or less than a fixed number. Previously, we used the balance scales to determine whether objects were heavier or lighter than each other, whereas now we can determine whether an object is heavier or lighter than a certain weight. The class should already understand the benefits and uses of standard units of measurement. Once the class is through with all the standard weights, use the balance scales to weigh the books. Have the class assist you. Try to get an exact mass for each book. During this weighing process, it should become quite clear that using balance scales to determine the mass of an object is actually quite difficult, especially when one has limited access to weights. At this point, introduce them to a more modern weighing scale that gives an exact mass, making sure that it is to the gram. Allow pupils to gather round as you weigh all 5 books. Write the mass of each book on the board so that they can then arrange them in ascending order. Take this opportunity to show them how these units and their abbreviations are written. Be careful to have measurements only in Kgs or in grams.

4.2
iv

Activity 6
20 min

Make groups of five to seven pupils and ask each group to incorporate "props" found around the class to prepare a skit of what would happen in real-life if one did not understand mass. To make sure they understand, ask them where mass is used in real-life. If they are having trouble brainstorming, give them the examples of luggage checks at the airport, buying fruits and vegetable by the kg, and even on pre-packaged foods at the grocery store. Allow a few minutes of class discussion to share ideas, and then let each group have 12 minutes to prepare their acts, telling them that they should seek to highlight the importance of understanding weight while also creating a sort of number story, so that each skit provides an addition or subtraction sentence. Ask them to keep numbers under 100, and skits between one and two minutes. After all of the skits, ask the pupils what number stories they were able to identify. Solve them on the board.

Let's try it

Assign up to ten addition and subtraction questions to pupils, using grams and kilograms as units, but only one unit at a time. Here are some examples of questions you can use:

- 1) An ice cream shop makes 10 kg of ice cream every morning to sell. One evening, as they close, they have 1 kg leftover. How many kgs were sold?
- 2) A boy needs 100 g of apple slices to make apple pie. Using a digital scale, he sets aside 500 g of apples, but after he slices them, and removes all the peels and cores, he only has 65 g of slices. How many more grams will he need to have the whole 100 g?
- 3) A girl had 30 grams of sugar in a jar. After she accidentally knocks it over, only 13 g of sugars in the jar. How much sugar did she lose?
- 4) A box of highlighters weighs 99 g. After all the pink ones are removed, the remaining highlighters weigh 48 g. How many grams of pink highlighters had been in the box?
- 5) Shehla's luggage allowance on her flight is 30 kg. She has one bag that weighs 18 kg and one that weighs 6 kg. How many more kilograms of luggage can she add before meeting her limit?

Let's Pause

As you teach pupils to measure liquids, enforce the fact that they must place the container on a flat surface, and look at it from eye level to get an accurate measure of how full the container is. This is especially important when using measuring cups, as looking from the wrong angle will cause the surface of the water to align with the wrong measurement mark.

4.3
i

Activity 7 15 min

Ask pupils how much water they have in their water bottles. They may be confused about answering this question, so ask them if they can think of any non-standard units for measuring liquids, like hand span for length. They will hopefully come up with ideas like jugs, cups, bottles. Some may suggest standard units but remind them to stick to non-standard. Then, provide as many water containers as possible. Examples include; fish bowls, cups, bottles, mugs, jugs. Remember that the same kind of container can be used in various sizes. Make the class into small groups and give each group a choice of up to three containers, making sure the groups swap every two minutes. While they have their containers, allow them access to water so that they can transfer water between each one, making note of how many times they could fill a cup without emptying a jug. This activity would be best done outdoors, to avoid a messy class, and also close to a tap and a drain if possible. Do remind pupils that water should never be wasted, so ask them to use as little as possible, and help you come up with a use for the water. At the end of the activity, explain the word capacity to the class.

Let's Pause

Pupils may struggle with the spelling of millilitre and litre, so be sure to give them plenty of practice writing them. Also point out the difference between the American and British spelling, explaining that both are correct, but that they should adhere to the British spelling for school.

4.3

ii

iii

Activity 8

15 min

Ask pupils if they have any idea what the standard units for measuring liquids are. Let them make suggestions, and then write ml and l on the board. Write millilitre and litre under their respective abbreviations. Explain that these are the units that we use to measure liquid, but ask them, if you use a ruler or measuring tape to measure length, and a weighing scale to measure mass, how could one potentially measure capacity? Ask them if any of them ever help their parents in the kitchen, and if they have ever seen a liquid measured out. The ideal answer would be a measuring cup, but pupils might also just say cup, or tablespoon. Establish with the class that the only way to measure a liquid is by putting it into a container meant for measuring. Then show them a cup, and any other measuring containers, that you could borrow from the science laboratory. Make groups and give each group a measuring cup that has markings in ml. Ask each group to fill the cups to the highest ml mark, and reduce it by 10 ml. Tell them to keep pausing to check the level, making sure they have not poured out more than 10 ml, reminding them that they will not get an accurate measure until they place the cup on a flat surface. Continue asking them to pour out small amounts, perhaps into plants around the school if the school staff is alright with that. Ask each group in advance to make sure to take note of how much they are pouring out and how much is left in the form of number sentences.

Let's try it

Assign up to ten addition and subtraction questions relating to real-life situations. The numbers should remain below 100. Here are some examples of questions you can use:

- 1) If Maryam buys 75 ml of chilli oil for a dinner party, and only 30 ml is used, how much chilli oil is she left with?
- 2) Aslam is making 100 ml of dip out of cream cheese, olive oil, and garlic puree. If he is using 10 ml of olive oil, and 20 ml of garlic puree, how much cheese should he use?
- 3) Syeda has two plants. Daily, she puts 30 ml water in one, and 25 ml in the other. How much water do the two plants require, in total, in a day?
- 4) In a day, Nusrat uses 11 ml of hand sanitiser. At the end of the day 23 ml remains in the bottle. How much sanitiser was in the bottle at the start of the day?
- 5) Sophia drops a new bottle of ink and 21 ml spill out. If there is 19 ml left in the bottle, how much ink was there before she dropped it?

Let's Pause

Pupils might find it confusing to identify what is suitable for measuring in litres and millilitres. Explain that these units are meant only for liquids but explain that sometimes substances like butter and cheese are measured in millilitres, depending on the texture. Ultimately, it is up to everyone to decide how best to measure what they need with the tools they have available.

Let's talk Math

Since these are the first measurement units the pupils will have learnt in class, ask them if they will be incorporating them into their lives at all. And if not now, do they think they will in the future? Where do they think measurement might be really important? Are there any situations where inaccurately measuring could lead mistakes? Allow the pupils to try to come up with examples, and also examine their own lives to see where knowing one's measurements could improve it. Also get them to think about when they see others using measurements. Ask them to try to come up with one example each. Allow the class 5 minutes to write a reflective write-up stating their thoughts on the unit.

Let's get practical

For this activity, pupils will be working on a recipe. Make groups of pupils up to six, and let them get to work. The recipe should include grams, millilitres, and centimetres. If you have access to an oven, try this recipe for biscuits. Be sure to handle the oven yourself, but let pupils do the measuring.

1 apple every 3 children, cut into 1 cm thick slices

- 240 ml water + 45 ml lemon
- 120 g peanut butter
- 20 g cocoa powder
- rainbow sprinkles
- chocolate sprinkles
- 100 g mini chocolate chips

Cut small circles out in the middle of each apple slice. Soak the apple rings into the water and lemon juice mixture for 5-10 minutes. Pat dry completely. Mix together the peanut butter and cocoa powder until smooth and well combined. Slather the peanut butter mixture over each slice. Add the toppings of choice.

Self Assessment

- 4.1 Length
- 4.2 Mass
- 4.3 Capacity

Refer to If they are struggling	Confusion level	1 – Does not understand any concept	2 – Does not understand most of the concepts	3 – Understands some concepts but has questions	4 – Understands all the concepts, just needs more practice	5 – Feels confident solving questions	If pupil is below 3 use Math Lab
	Number of Pupils						

Multiple Choice Questions

Read out the questions or write them on the board. You may ask pupils to either write the correct answer on a white board and hold it up or call out the options one by one, asking them to raise their hands to show which one they have chosen.

- 1) What can we measure with centimetre?
 - a) The mass of a book
 - b) The height of a bottle
 - c) The capacity of a swimming pool

- 2) It takes 25 jugs of water to fill up Asim's bath tub. After he pours in the 13th jug, the jug falls and breaks. How many more jugs would Asim have poured?
 - a) 15
 - b) 10
 - c) 12
 - d) 13

- 3) Which of the following is a measure of mass?
 - a) Kilogram
 - b) Litre
 - c) Metre
 - d) None of the above

Unit 5

Time

5.1 Time

- i. Recognise the number of hours in a day and numbers of minutes in an hour.
- ii. Read and write the time from a clock in hours and minutes (with five-minute intervals) e.g. read 8:15 as eight fifteen and 8:50 as eight fifty.
- iii. Recognise a.m. and p.m.
- iv. Draw hands of a clock to show time in hours and minutes (with five minutes intervals).
- v. Use solar calendar to find a particular date/day.
- vi. Use Islamic calendar to find a particular date/day.

Plan Ahead:

5.1 Time

Allocate realistic time frame/number of periods to teach each topic as per requirement.

Before You Start:

Pupils are familiar with time and with both kinds of clock. In this Unit they will learn more about how to tell time more specifically, but they should first be absolutely comfortable with the concept of time. The pupils should also be able to name the months of Islamic and solar year to familiarise themselves with the calendars.

Watch Out For:

This Unit simply refines the knowledge pupils already have about time. Any uncertainty about concepts previously learned will make it harder to move through the unit, so it would be a good idea to start with a class discussion that could serve as a quick revision. Just catching some pupils up to speed will be helpful. Also, calculating which number on the clock signifies how many minutes will seem very tricky to pupils who don't have a lot of experience with mental math. Assure the class that they are free to write out the working if they need to.

This Pairs with:

Math Lab 2 pages 65 to 66.

Make Sure You Have:

Globe	Analogue clock
Torch	Digital clock
Signs for a.m. and p.m.	Calendars (Islamic and solar)

If They are Struggling:

If pupils are struggling to read the minute hand on analogue clocks, it would be helpful to have the whole class go over the five times table. If the problem persists, then you will know that it stems from an issue of understanding. Relate the clock to the five times table, and assure pupils that if they understand that, the clock will be no issue. Also, remind them that if they remember that when the minute hand points to 3 it is 15 minutes after the hour, 6 is 30 minutes, and 9 is 45 minutes then they can work out what time it is slightly faster. The class may also be confused about learning both calendars together, so make it very clear that they must learn both, and give an equal amount of time to both.

When you see the confusion bar, take note of how many pupils fall under each level. If pupils are at a level 3 or below, have them solve the equivalent Math Lab pages in pairs, having weaker students work with more confident students. First do allow the class to collectively ask questions. If all pupils are at level 4 or above, move on to the next activity.

Let's Begin

Use a globe and a torch to demonstrate how the Earth rotates and the Sun shines on the Earth. Students are not yet expected to understand how the Earth's rotation explains night and day, but the visual image of the rotation of the Earth taking 24 hours from midnight to midnight helps students to understand the concept. Ask pupils what they think people would have done before clocks. Ask them what other indicators there are that the day is moving forward or coming to an end. Encourage them to come up with more than just the movement of the Sun. Ask them if they feel different as the day progresses. Ask them if they think there is any alternative way to live in the modern-day world without using time. Allow them to brainstorm and share ideas, seeing how creative they can be. Ask them each to write down their favourite idea in their notebooks so that they can refer back to it at the end of the unit.

SLOs

5.1
i

Activity 1
10 min

This pairs with Math Lab page 65

Write on the board; days, minutes, hours. Ask pupils to help you put them in order of largest to smallest. They will likely already be aware of what minutes are. Then ask, how long an hour is. While the right answer is 60 minutes, pupils might be confused about how to answer the question. Given that hours are a unit of time, and they may not be familiar with the idea of conversion, you may eventually have to tell them the answer. Explain that after one minute has passed, sixty times, a whole hour has passed. Ask them then, how long a day is. If no one knows the answer, tell them 24 hours. Hold up a clock in front of the class. Point out that one round of the clock by the hour hand is an hour, but the minute hand, in one round makes 60 minutes. Then point out how the clock makes 24 rounds each day.

Let's Pause

Pupils might find it confusing when an hour hand is in between numbers. Explain that if that is the case, the time is the number that it has passed, not the one it is about to reach.

SLOs5.1
ii**Activity 2**
10 min

Using an analogue clock, explain to pupils verbally how to read time. Explain that all they must do is read the number the hour hand and is pointing to and then the minute hand. Pupils might find it confusing to read the minute hand, so remind them that this is where their five times table will come in handy. Ask each of them to find it in their notebooks so that they can refer to it if need be. Explain that when the minute hand is pointed at 3, they must multiply 3 by 5, concluding that it is 15 minutes past the hour. If it is pointed at 6, then it is 30 minutes past the hour. Once they are comfortable with an analogue clock, show them how to read a digital clock, also with the minutes being multiples of 5.

Let's try it

Tell the class you are doing a silent exercise, so no one can speak. If they have an urgent question, they must raise their hands and wait to be called on. They must remain at their desks, you will be showing them a clock, and they must be ready with their notebooks to write down the correct time shown. Show them at least fifteen times and ask them to peer review. Only show times where the minute hand is pointing to a multiple of 5.

Assign classwork from the textbook so pupils can practice what they have learned.

Let's Pause

a.m. stands for ante meridiem and p.m. stands for post meridiem. These are Latin words, the former meaning before midday, and the latter; after midday.

5.1
iii**Activity 3**
15 min

This pairs with Math Lab page 66

Ask the class they do at one o'clock on a weekday. They might respond by naming the class or activity they usually have at that time. Or they may simply say that they are in school. Give them about 30 seconds to put forward their answers. Then stop them and say that you tend to be asleep at one o'clock during the week. Some might be confused, but others may understand that you are referring to 1 a.m. Remind pupils that although there are 24 hours in a day, the hours on the clock only go up to 12. This means each time happens twice. Once while the sun is rising, and once while the sun is setting. Allow the pupils a moment to wrap their heads around this. Then ask them if they think it could be problematic to have every time happen twice a day. If you ask someone to meet you at dinner for 8, it is probably a fair bet that they will not expect dinner at 8 in the morning, but situations are not always so easy to distinguish between. Point out that flights land throughout the day, and night. If someone told you their flight was landing at 6, it could mean morning, or night. Ask pupils if they know an easy way to distinguish between 8 in the morning and 8 in the evening. Regardless of whether they know, write a.m. and p.m. on the board. Explain that a.m. refers to all times that are after midnight and before noon, while p.m. refers to times that are after noon, but before midnight. Be sure to specify that midnight is always 12 a.m., and noon is 12 p.m. Once this is understood, tell them you will be reading out some scenarios and the time they occurred at, and pupils will have to hold up a sign saying a.m. or p.m. to vote. They can easily make these with paper from their notebooks. Here are some examples of scenarios you can use:

- 1) I had breakfast at 8 o'clock (a.m.)
- 2) I went to sleep at 9 o'clock (p.m.)
- 3) I watch my favourite show every weekend at 10 o'clock (p.m.)
- 4) I started a new book at 1 o'clock (p.m.)
- 5) I baked cookies for my parents at 7 o'clock (p.m.)
- 6) I took my dog to a nearby park for a walk at 10 o'clock (a.m.)
- 7) I set my alarm for 9 o'clock (a.m.)
- 8) On my birthday, I invited my friends over for cake at 4 o'clock (p.m.)
- 9) Every day I do a quick workout at 8 o'clock (a.m.)
- 10) Yesterday I accidentally left home without my phone at 6 o'clock (p.m.)

Most of these would have been quite easy for pupils to sort as the activities listed are specific to a certain time of the day. However, some of these scenarios could have occurred, both in the morning, and the evening, like watching a television show, or doing a workout. Therefore, it is important that there is a quick way of always specifying time.

Let's try it

Ask pupils, as a class project to create a personal timetable, for two days. One should be any day in the pupil's own life, and one should be a day in the life of their favourite fictional character. Ask them to use chart paper and give them some examples on the board of what it should look like. Let them know they can pick up ideas from their class timetable. The only requirements are that they cover all 24 hours for both days, and that they mention a.m. or p.m. next to each time. They can make it in a list format, or a table. Encourage them to be creative with design, and remind them that both timetables must allot at least 8 hours for sleeping (exceptions might have to be made for fictional character, depending on who they are). This can be set as classwork, or homework.

Let's Pause

Make sure pupils know, when they draw clocks, the minute hand is generally a little longer than the hour hand.

Refer to If they are struggling	Confusion level	1 – Does not understand any concept	2 – Does not understand most of the concepts	3 – Understands some concepts but has questions	4 – Understands all the concepts, just needs more practice	5 – Feels confident solving questions	If pupil is below 3 use Math Lab
	Number of Pupils						

Assign 20 minutes of textbook questions as classwork.

5.1
iv

Activity 4
7 min

Ask pupils to follow along with you in your notebooks as you draw on the board. Start by drawing a circle. Then write 12, 3, 6, 9 with 12 at the top, 6 at the bottom, and 3 and 9 on either sides, as they would go on a clock. Point out that when drawing a clock, writing these four numbers first makes it easier to place the rest. Then write the rest of the numbers and make a dot in the centre of the circle. Ask pupils to give you a time. Once you have one, draw it onto your clock. Then ask for another time. Ask the class to help you decide where to place the hands of the clock to reflect that time. Do this until you are confident that all pupils understand the placement of hands on an analogue clock.

Let's try it

If possible, hand out a worksheet with 9 clocks printed on it, without hands. If a worksheet can't be made, have pupils draw the circles in their notebooks and fill in the numbers by looking at what they drew in their notebooks in the previous activity. Let them know that the circle do not have to be exactly perfect circle, and that the number placement is more important. Ask them to draw hands on each of them to show the following times:

- 1) 8:30
- 2) 4:45
- 3) 3:15

- 4) 6:25
- 5) 2:55
- 6) 9:05

- 7) 3:00
- 8) 10:35
- 9) 11:10

5.1
v

Activity 5
5 min

Place a large calendar in front of the class and open it to the front page. Although the pupils will have studied the months of the year, but might need a refresher, in which case, flip through the calendar once, reading the months aloud. Show the pupils how the calendar can be used to find out what the of the week will fall on a specific date, as well as what date it will be on a certain day of the week. For example, you can check what the date will be next Saturday, as well as what day the last day of the month will be on. Ask pupils to help you find three to five more dates and allow them to come forward and examine the calendar. If possible, pass some smaller calendars around the class.

Let's try it

Ask pupils beforehand to get the birthdays of at least five people who are not in the class. They could be parents, siblings, or grandparents. Then, depending on how many calendars you have available, ask them to find out what day of the week each of the five birthdays fall on. Pupils can be requested to bring desk calendars from home if they are able, and hopefully there will be enough for three to four pupils to share one. If not, do this as a class activity with the large calendar.

Assign 20 minutes of textbook questions as classwork.

5.1
vi

Activity 6
10 min

The Islamic calendar will also be familiar to the pupils but go over the months once for their revision. They are as follows:
Muharram, Safar, Rabi-ul-awwal, Rabi-ul-Sani, Jammadi-ul-Awwal, Jammadi-ul-Sani, Rajab, Sha'ban, Ramadan, Shawwal, Zul-Qadah, Zul-Hajjah. Allow pupils to examine the actual calendar, and if there are smaller versions available, pass it around. Then, if there are multiple calendars available, make groups for a group activity. The number of groups should be the same as the number of calendars available. If there are not enough, do this as a class activity. Find out which day of the year, the first of each of the Islamic months falls on. So, by matching the Islamic and the solar calendar, find out which date on the solar calendar is the first of Muharram, Safar, Rabi-ul-awwal, and so on.

Let's try it

If this activity is not doable in the class, assign it as homework. Ask pupils to use the internet, under supervision, to find out what date of the Islamic calendar they were born on. Then ask them to go through the calendars from the year they were born, to the present year, and find out which date on the solar calendar their Islamic birthday fell on each year. Let them know that it will be a different date every year. Ask them to make note of this in their exercise books so that you can make sure it was done right.

Assign 20 minutes of textbook questions as classwork.

Let's talk Math

Ask pupils if the way that they see time has changed since they last studied it. Do they think it is any more or less important, and did they find it easier? Then ask them to flip back in their notebooks to the start of the Unit to see what they wrote down during the Let's Begin, and ask them to consider, given what they have learnt about time so far, do they still think their alternative is better? Ask the students to give reasons to support their yes or no answer. At the end of the discussion, ask them to take 5 minutes to write a reflective paragraph about what they learnt during this unit.

Let's get practical

Ask pupils to create their own calendar sheet of their birthday month. Allow them to choose whether they would like to use the Islamic calendar or the solar one. They should each choose a month, and then, on a chart paper, create a calendar sheets showing the days of the week during that month, with plenty of space to write in each day. Encourage them to be creative and decorate their calendars however they like. Ask them to make note of their routine during the average weekday and weekend day. It only needs to show; wake up time, breakfast, lunch, dinner, and bedtime. In this format: 9:50 a.m. Then, on their birth date, they should draw a miniature analogue clock to show the time they were born, correct to the nearest five minutes.

Self Assessment

5.1 Time

Refer to If they are struggling	Confusion level	1 – Does not understand any concept	2 – Does not understand most of the concepts	3 – Understands some concepts but has questions	4 – Understands all the concepts, just needs more practice	5 – Feels confident solving questions	If pupil is below 3 use Math Lab
	Number of Pupils						

Multiple Choice Questions

Read out the questions or write them on the board. You may ask pupils to either write the correct answer on a white board and hold it up or call out the options one by one, asking them to raise their hands to show which one they have chosen.

- How many hours in a day and minutes in an hour?
 - 25 hours in a day and 60 minutes in an hour
 - 24 hours in a day and 50 minutes in an hour
 - 24 hours in a day and 60 minutes in an hour
 - 25 hours in a day and 50 minutes in an hour
- What time is shown on this analogue clock? (Here, draw a clock on the board showing 3:55)
 - 3:50
 - 3:25
 - 3:30
 - 3:55
- What is the purpose of a.m. and p.m.
 - a.m. is used for analogue clocks, and p.m. is used for digital
 - a.m. is a different way of keeping time from p.m.
 - a.m. time is before noon, and p.m. time is after noon, but before midnight
 - None of the above

Unit 6

Geometry

6.1 Two Dimensional Figures

- i. Identify the figures like square, rectangle, triangle, circle, semi-circle, and quarter-circle.
- ii. Identify vertices and sides of a triangle, rectangle, and square.

6.2 Straight Lines and Curves

- i. Differentiate between a straight line and a curve.
- ii. Identify straight lines and curves from the given drawings.
- iii. Use ruler to draw a straight line of given length (exclude fractional length).

6.3 Patterns

- i. Make/complete geometrical patterns on square grid according to one or two of the following attributes.
 - Shape
 - Size
 - Orientation

6.4 Three Dimensional (3-D) Objects

- i. Recognise and name 3-D Objects (cubes, cuboids, cylinder, cone, sphere).

Plan Ahead:

- 6.1 Two dimensional figures
- 6.2 Straight lines and curves
- 6.3 Patterns
- 6.4 Three dimensional (3-D) objects

Allocate realistic time frame/number of periods to teach each topic as per requirement.

Before You Start:

Pupils are familiar with 3-D and 2-D shapes from their daily life. They have seen and held objects, such as a ball (a sphere), a dice (a cube), a toothpaste box or a lunch box (a cuboid), an ice cream cone (a cone), etc. They have also felt the flatness of shapes, such as a floor tile (a square) or a windowpane (a rectangular), a round plate (a circle). They have a visual idea of what each looks like, but often get confused with names. At this level their knowledge of shapes takes a slightly more formal shape.

Watch Out For:

Make sure to give plenty of time for pupils to get used to names, especially when introducing the 3-D shapes at the end of the Unit.

This Pairs with:

Math Lab 2, page 67 to 71.

Make Sure You Have:

Foam sheets Rulers
Scissors A4 Sheets
Markers Playdough

If They are Struggling:

Pupils may become frustrated trying to be accurate when constructing lines, so do not give them too much practice in one go. Also relate the line of symmetry to mirrors, and use real life examples of shapes. When you see the confusion bar, take note of how many pupils fall under each level. If pupils are at a level 3 or below, have them solve the equivalent Math Lab pages in pairs, having weaker students work with more confident students. First do allow the class to collectively ask questions. If all pupils are at a 4 or above, move on to the next activity.

Let's Begin

Ask the class to volunteer any information they remember about shapes, and which shapes they can name. As they name the picture, ask them to come up to the board and draw them. Write the name of each shape down next to them. When they are done, if there is a circle, a square, a rectangle, and a triangle on the board, group them together, and tell the class that these are the shapes they should focus on. If one of them is missing, add it, and explain to the class what it is called. For the purpose of this activity, include all the shapes on the board. Ask pupils if they see any similarities, or differences. Try to prompt them to be aware of the lines. Which ones are curved, and which ones are straight, even if the circle is the only shape on the board that does have a curved line.

SLOs

6.1
i

Activity 1
20 min

This pairs with Math Lab page 67

Square, rectangle, triangle and circle are shapes that the class should already be aware of. The new introductions are only semi circles and quarter circle. Make groups of four to six pupils and hand out foam sheets, markers, and child friendly scissors. Ask each group to make cut outs of each shape, being very careful with the scissors, and making sure to draw them with a marker first. Remind them that with the semi circle and the quarter circle, it might be easier to draw a full circle and then draw a line through it, or even just cut it in half. Also remind them to make sure the sides of the square are as equal as possible.

6.1
ii

Activity 2
6 min

Allow pupils to pass their foam shapes around during this activity and keep a square so that you can demonstrate. Ask the class if they know what vertices are. Explain that they are the corners of the shape, and that number of sides and number of vertices are two of the characteristics that are most often used to identify shapes. Ask the class to help you count the number of vertices and sides on the square you're holding. At this point, ask them to stop passing their foam shapes. Ask each of them now, to stand at their desks for just long enough to hold up the shape they have and state the number of vertices and sides. The pupils holding the circle and semi circle and quarter circle need not count sides and vertices. They may simply name their shape.

6.2
i
ii

Activity 3
10 min

This pairs with Math Lab page 68

Ask pupils about the previous activity. Which shapes did they not identify the vertices of? Ask a volunteer to come and draw all six shapes on the board. Ask pupils, what sets the square, the rectangle, and the triangle apart from the other three shapes. The aim is, that they should pick up on the fact that the circle, the semi circle, and the quarter circle involve curved lines, whereas the other shapes do not. Establish the fact that while all the lines in the first three shapes are straight, one of the lines in each of the last three shapes is curved. Ask pupils to come to the board and draw an example of a curved line and a straight line. Then tell them to look around the class and point out where they see curved lines and straight lines.

Refer to If they are struggling	Confusion level	1 – Does not understand any concept	2 – Does not understand most of the concepts	3 – Understands some concepts but has questions	4 – Understands all the concepts, just needs more practice	5 – Feels confident solving questions	If pupil is below 3 use Math Lab
	Number of Pupils						

Let's try it

Present each pupil with a picture, possibly from a colouring book, that includes straight lines and curved lines. Ideally, it will be very simple, and will not confuse pupils. If such a picture can't be found, make a simple drawing and photocopy it. Ask the pupils, in pairs, to go through the and identify as many curved lines and as many straight lines as possible, by outlining them with differently coloured highlighters, or markers. Use as many pictures as necessary for them to spend at least 10 minutes on this exercise.

6.2
iii

Activity 4
7 min

Ask pupils to observe straight lines they see in their immediate surroundings. Point out the ceiling, the windows, the door, and how all of these things had to be made of a very precise size. Discuss how when, constructing lines, for a purpose, as a designer, or an architect, or even just when you are making a drawing, one need to be as accurate as possible. Ask pupils to come to the board and ask them to draw a line. When they have done so, ask how they decided how long it should be. How did you know where to start it and where to end it. Explain to the class that while these pupil chose for themselves what the length of their line would be, sometimes, when drawing a line for a reason, it has to be a certain length. Ask pupils how they would go about drawing a line of a prescribed length. What tools would they use? At this point, some of them may have reached the conclusion that they would be able to use a ruler. Ask if anyone would like to come to the board to show the class how to do it. If no one volunteers, draw a line yourself, keeping in mind the only distance measuring units pupils have learnt so far are metres and centimetres.

Let's try it

Ask pupils to draw lines of the following lengths in their notebooks, or on an A4 sheet if the notebooks are too small. Remind them that drawing a line diagonally will make it fit better. This is individual work to be done at their desks.

1) 2 cm

3) 9 m

5) 13 cm

2) 5 cm

4) 10 cm

6) 17 cm

6.3
i

Activity 5
15 min



Ask pupils to help you continue it, and then ask what the pattern is. Previously, they learnt about patterns that had different shapes. This pattern has the same shape, but it has one key difference. They should pick up on this, so when they point it out, be sure to highlight that even though the patterns they learnt previously had a series of different shapes, one can make a pattern with anything. Then, present this pattern:



Orientation is another way that one could make a pattern. Write the following on the board; shape, size, orientation. These are the three ways in which an object in a pattern could differ from another. Pupils must be conscious of all three when working to identify pattern. Present the class with at least four more patterns to solve on the board before wrapping up the activity.

Let's try it

Present pupils with five or more patterns on the board to copy down and complete. They should only include circles, triangles, squares, rectangles, and the variations should be based on size, shape, and orientation. Here are some examples of patterns you could use:

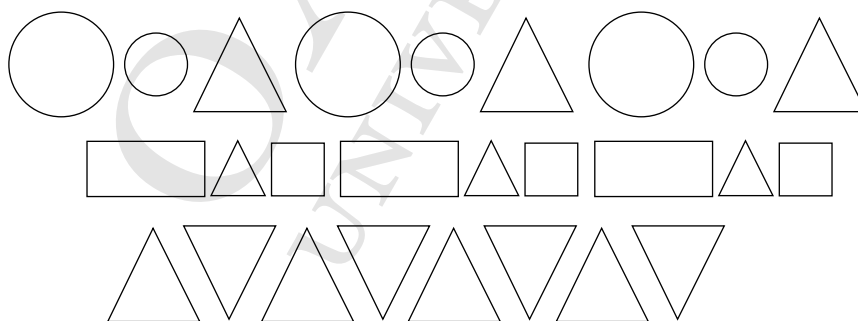

6.3

i

Activity 6

15 min

Divide the class into two groups. Make sure that there are pupils of varying ability in each group. Tell them they will be having a competition, and the group that is the best at working as a team will win. Hand each child an A4 sheet, and ask them to draw three patterns on them, making sure to leave plenty of space so that the patterns can be continued. Explain that once each one of them have made a sheet of three patterns they should write their name in the corner, and all hand their sheets to you. Then make two stacks of worksheets, one from each group, and swap them, giving each group, among themselves the other team's worksheets. Each team must then distribute the worksheets, there should be one per pupil, and solve them. The first team to get through all the worksheets will win. They can definitely help, or seek help from, teammates. An important rule is that if anyone designs a worksheet of patterns that does not make sense, or is unsolvable, then they will be disqualified. If any worksheets remain unsolved at the end of the game, solve them on the board. Make sure to give pupils at least six minutes to design their worksheets and remind them they can brainstorm in their notebooks.

This pairs with Math Lab pages 70 and 71

Give each pupil a lump of playdough. Ask them to make squares. Make one yourself as well. After a minute, draw a square on the board. Then ask the class, "What's the difference between the square on the board and the playdough square?". Allow them to guess, and then explain the concept of the third dimension. Explain that the square on the board has height and width, but the play dough square, even if they are quite flat, the still have some depth. Use the idea of 3-D movies as an example of depth. Then draw on the board, next to the square; a circle, a rectangle, a triangle. Explain then that a square in three dimensions is called a cube. They are not the same shape, but since they are quite similar, they often are linked together. This is because the faces of a cube are squares. Ask the class if they know a 3-D shape that could be linked to the other three shapes. If they come up with anything other than cuboid, cone, cylinder, and sphere, write it down, and draw it in the corner of the board, but say that it is not what you're looking for. Give them two minutes to guess, before drawing the aforementioned 3-D shapes. Ask the class now, to pay attention to how the cube has been drawn differently from the square, and the same with the cuboid. The sphere, however, on the board, will look just like a 2-D circle. Explain that a sphere is hard to draw because of its lack of edges, but that's what the playdough is for. Ask the pupils to copy you, as you roll your playdough, allowing the class to follow you. Then do the same with the cylinder, the cuboid, and finally, the cube.

6.4

i

Activity 7

20 min

Assign 15 minutes of classwork from the textbook so that pupils can revise these concepts.

Let's talk Math

Discuss how we have different sized and shaped objects around us. We can see triangles, squares, and circles everywhere. Some of these shapes have length, breadth, and height and are 3-D (three-dimensional) objects. For example houses have length, breadth, and height and are 3-D objects. Others like a sheet of paper can be imagined to have a length and a breadth only. Such objects are two-dimensional and are thus 2-D shapes. Ask pupils why they think it is important to have different names for 3-D shapes and 2-D shapes. Why not call a cube a 3-D square? Prompt them to discuss what kind of confusion it would lead to. Encourage them to think about the third dimension, and ask them how much it changes the shape. Remind them that once a square becomes a cube, it has more vertices, and more sides, so it is not really the same shape. A 2-D shape can be the face of a 3-D shape, but that do not make them the same shape.

Let's get practical

Divide the class into groups of 4 to 5 pupils. Ask each group to create a sequence using the 3-dimensional shapes they have just learnt about. Give them 10 minutes to plan the sequence, reminding them to take into account the resources available to create it, and also, how much time they have. Then ask them to create the sequence. Give each team an equal amount of playdough, and tell them to leave just enough to make four more shapes. It should be clear when they are finished what the pattern is. Once they are finished, ask all the groups to arrange their shapes at the front of the class, and allow them all to take their seats. Then have the class help you add four more shapes to each sequence, asking to group that created it not to help.

Self Assessment

- 6.1 Two Dimensional Figures
- 6.2 Straight Lines and Curves
- 6.3 Patterns
- 6.4 Three Dimensional (3-D) Objects

Refer to If they are struggling	Confusion level	1 – Does not understand any concept	2 – Does not understand most of the concepts	3 – Understands some concepts but has questions	4 – Understands all the concepts, just needs more practice	5 – Feels confident solving questions	If pupil is below 3 use Math Lab
	Number of Pupils						

Multiple Choice Questions

Read out the questions or write them on the board. You may ask pupils to either write the correct answer on a white board and hold it up or call out the options one by one, asking them to raise their hands to show which one they have chosen.

1) Which of the following shapes has three sides and three vertices? (Draw the following on the board)

- a) Triangle
- b) Square
- c) Circle
- d) Rectangle

2) Which of the following would complete this pattern? (Draw the following on the board)

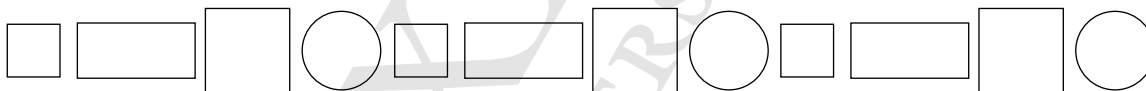

- a) Small square, rectangle, big square, circle
- b) Rectangle, big square, circle, small square
- c) Small square, , big square rectangle, circle
- d) Circle, small square, rectangle, big square

3) which 3-D shape is this object? (Hold up an example of a sphere)

- a) Sphere
- b) Cylinder
- c) Cone
- d) None of the above

OXFORD
UNIVERSITY PRESS

NEW

COUNTDOWN

BOOK 2

Lesson plans to be used in conjunction with the
New Countdown book series.

Features of the Lesson Plan

The lesson plan contains the following features. The headings through which the teachers will be led are explained as follows:



Suggested Time Frame

Timing is important in each of the lesson plans. The guide will provide a suggested time frame. However, every lesson is important in shaping the behavioural and learning patterns of the students. The teacher has the discretion to either extend or shorten the time frame as required.



Learning Curve

It is important to highlight any background knowledge of the topic in question. The guide will identify concepts taught earlier or, in effect, revise the prior knowledge. Revision is essential, otherwise the students may not understand the topic fully. The initial question when planning for a topic should be how much do the students already know about the topic? If it is an introductory lesson, then a preceding topic could be touched upon, which could lead on to the new topic. In the lesson plan, the teacher can note what prior knowledge the students have of the current topic.

Each topic is explained in detail by the author in the textbook supported by worked examples. The guide will define and highlight the specific learning objectives of the topic. It will also outline the learning outcomes and objectives.



Real-life Application

Today's students are very proactive. The study of any topic, if not related to practical real-life, will not excite them. Their interest can easily be stimulated if we relate the topic at hand to real-life experiences.



Frequently Made Mistakes

It is important to be aware of students' common misunderstandings of certain concepts. If the teacher is aware of these they can be easily rectified during the lessons. Such topical misconceptions are mentioned to support teachers.



Summary of Key Facts

Facts and rules mentioned in the text are listed for quick reference.



Suggested Activities

This teaching guide provides you enough hands on activities for making your lesson plan more interesting and engaging. These activities will have more impact on students' learning.



Model Lesson Plan

Planning your work and then implementing your plan are the building blocks of teaching. Teachers adopt different teaching methods/ approaches to a topic.

A model lesson plan is provided in every unit as a preliminary structure that can be followed. A topic is selected and a lesson plan is written under the following headings:

Topic

This is the main topic/sub-topic.

Duration

The suggested time duration is the number of periods required to cover the topic. Generally, class dynamics vary from year to year, so flexibility is important.

The teacher should draw his/her own parameters, but can adjust the teaching time depending on the receptivity of the class to that topic. Note that introduction to a new topic takes longer, but familiar topics tend to take less time.

Specific Learning Objectives

This identifies the specific learning objective/s of the sub-topic being taught in that particular lesson.

Key Vocabulary

List of mathematical words and terms related to the topic that may need to be pre-taught.

Resources: Teaching and Learning Aids (Optional)

This section includes everyday objects and models, exercises given in the chapter, worksheets, assignments, and projects.

Strategy

Starter: Engagement Activity

The lesson can begin with something interesting, such as telling a story, relating a real-life experience or an everyday event which may or may not lead to the topic; but is interesting enough to capture the attention of the students. Involving students in a discussion to find out how much knowledge they have of the topic being taught is also a good strategy. Teachers can use their own creativity to come up with ideas to create a sense of fun.

Main Developmental Activity

Learning needs to start with practical activities, therefore the main developmental activity is the first step that leads to actual learning, which in turn leads to the required outcome of the lesson. This activity can be planned as individual work, pair or group work as per requirement. Working individually creates self-confidence where the child enjoys a sense of self-achievement, whereas pair and group activities create a sense of discovering and learning together.

These activities enhance concentration and improve retention of memory. Through these activities the teacher can build understanding of concepts in a fun-filled way. It is easier for students to grasp the concepts and then move from abstract to concrete.

Written Assignments

Finally, written assignments can be given for practice. It should be noted that classwork should comprise sums of all levels of difficulty, and once the teacher is sure that students are capable of independent work, homework should be handed out. For continuity, alternate sums from the exercises may be done as classwork and homework.

Supplementary Work (Optional): An activity or assignment could be given. It could involve group work or individual research to complement and build on what students have already learnt in class.

The students will do the work at home and may present their findings in class.

Wrap up

At the end of each sub-topic, a wrap up should be done using various strategies. For example, a quick question and answer session involving the whole class, challenging students with a question to check their understanding of the concept taught.

1

Whole Numbers



Suggested Time Frame

10 to 12 periods



Learning Curve

Previously students have been working with numbers up to 99. They know hundred rupees and have seen a hundred rupee note. Hundred has to be introduced as addition of 1 to 99 following the same pattern as in 10, addition of 1 to 9. Then, they learn to work with 3-digit numbers.



Real-life Application

Numbers play an important role in our daily life. They are directly or indirectly connected to our daily routine. We find numbers involved in:

- home address
- phone numbers
- telling time
- measuring objects
- cooking
- prices and discounts
- number of peoples in a gathering
- profit and loss in the business
- paying bills



Frequently Made Mistakes

- Get confused when using the sign of greater than and smaller than correctly.
- Do not place the numbers in the place value chart correctly.



Summary of Key Facts

- 3-digit numbers are greater than 2-digit numbers.
- Comparison and ordering of numbers depends upon the place values of the digits.



Model Lesson Plan

Topic

Comparing and ordering 3-digit numbers

Duration

80 minutes

Specific Learning Objective

By the end of the lesson, students will be able to compare 3-digit numbers using the terms 'greater than' and 'smaller than' and symbols ($>$ or $<$), and arrange a set of numbers in ascending and descending order.

Key Vocabulary

ascending, descending, greater than, smaller than, order, and place value.

Resources

White board, a place value chart with H, T, and O.

Strategy

Engagement Activity (10 minutes)

Show them two 3-digit numbers on the board, ask them which number is greater and how they know.

Main Developmental Activity (25 minutes)

Stick the place value chart having H, T, and O columns, in one corner of the board. Review the topic of place value to hundreds. Write a 3-digit number in the place value chart. Ask the value of each digit.

Revise comparing 2-digit numbers by writing two 2-digit numbers, 43, and 63, on the board. Involving the students, compare digits in the tens place. If they are equal, move to the ones place and decide which of the numbers is greater. Ask the pupils to answer with the appropriate term i.e. using greater than or smaller than. Then ask them to put the appropriate sign ($>$ or $<$) between the numbers.

Now, explain that the same method is applied when comparing 3-digit numbers. Write two 3-digit numbers in the place value chart. Starting from the hundreds place the pupils will compare the digits in each place value and decide which one is greater. Then they will decide the appropriate sign ($>$ or $<$). If they are confused with the signs, recall the idea that the open mouth of a hungry crocodile always moves towards the greater number.

Using their learning of comparing 3-digit numbers, they can consequently arrange a set of numbers in ascending and descending order.

2

Addition



Suggested Time Frame

6 Periods



Learning Curve

Students know how to add numbers in the tens column and ones column using the abacus and the number line. They now review addition of 1-digit numbers and later 2-digit numbers without carrying over. Word problems are also given to make learning relevant and the students learn and apply in everyday life situations. This makes the study fun and interesting.

Once this is clear, students add 3-digit numbers with 3-digit numbers without carrying over. Next, they learn addition with carry over i.e., the students learn how to group ones into 10, then tens into 100s.



Real-life Application

Addition is a basic operation applied in all aspects of life. We use addition for buying, selling, cooking, measuring, and many other things.



Frequently Made Mistakes

- Numbers not written in correct places.
- Confusions during borrowing and carrying forward.
- Not regrouping the numbers correctly.



Summary of Key Facts

- Addition of numbers is commutative.
- Zero added to zero results in zero.
- Zero added to a number does not change the number.
- Any number added to itself is the same as doubling the number.



Model Lesson Plan

Topic

Addition of 3-digit numbers with carrying.

Duration

40 minutes

Specific Learning Objective

The students will be able to add two 3-digit numbers with carrying and without carry forward.

Key Vocabulary

2-digit, 3-digit, carry, and carry forward.

Resources

Bundles of ten pencils and a few loose pencils, cards having different numbers of stars.

Strategy

Engagement Activity (5 minutes)

Tell the students they have four bundles of ten pencils and 8 loose pencils and you have three bundles of ten pencils and 4 loose pencils. How many pencils are there altogether?

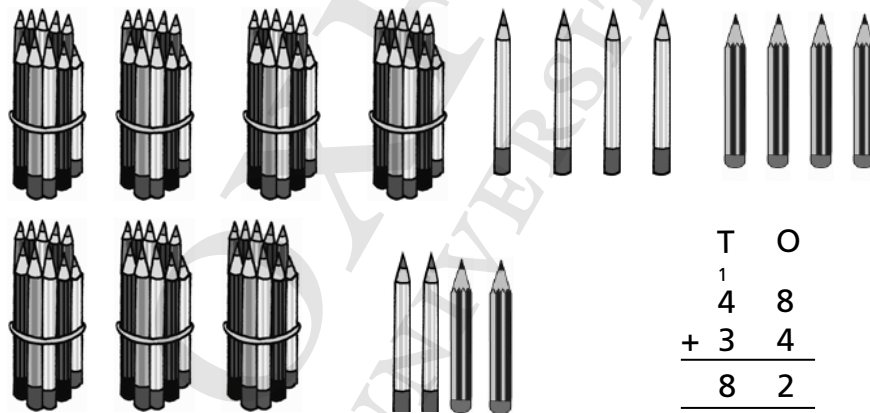

Main Developmental Activity (25 minutes)

Instead of solving 3-digit addition problems directly in the notebooks, solve the sums through an activity using star card. Group the students in pairs. Considering that they have already done the addition of 2-digit numbers with/without carrying forward, ask each pair to draw 6 cards. They will make two 3-digit numbers from the cards as shown opposite.



Students will add the numbers and write their answers below the two lines of cards

OXFORD
UNIVERSITY PRESS

3

Subtraction



Suggested Time Frame

6 to 8 periods



Learning Curve

Students have already learnt to subtract Tens and Ones using the abacus and the number line. They have learnt to subtract two 2-digit numbers. They are able to find the unknown by completing the equations such as $\text{---} + 4 = 7$.

Now they will learn to group ones into 10, then tens into 100s. They will also be able to subtract two 3-digit numbers with/ without borrowing.



Real-life Application

The method of subtraction is applied to billing, purchasing, dividing, and handling money etc.



Frequently Made Mistakes

- Writing numbers incorrectly.
- Writing wrong numbers as a result of carelessness.



Summary of Key Facts

- Symbol used for subtraction and equality are $-$ and $=$ respectively.
- Subtraction can be performed on a number line.
- Subtraction equations can be constructed to find the difference or missing number in the subtraction sum.
- Numbers are not commutative with respect to subtraction.



Model Lesson Plan

Topic

Subtraction

Duration

80 minutes

Specific Learning Objective

By the end of the lesson, students will be able to perform subtraction of two 3-digit numbers with borrowing.

Key Vocabulary

subtract, take away, less, minus, left over, and take out etc.

Resource

Bundles of ten pencils and a few loose pencils, cards having different numbers of stars.

Strategy

Engagement Activity (10 minutes)

Tell the students that they have 4 bundles of ten pencils and 8 loose pencils. They need to give away 2 bundles of ten pencils and 9 loose pencils to a friend, Ahad. How many pencils are left over?

Start from single pencils, 9 pencils cannot be given away from 8. So, one bundle of 10 pencils needs to be opened and 8 pencils can easily be given away from 18 pencils.

Main Developmental Activity (30 minutes)

Instead of solving 3-digit subtraction problems directly in the notebooks, solve the sums through an activity with stars cards. Group the students in pairs. Considering that they have already done the addition of 2-digit numbers with/without borrowing, ask each pair to draw 6 cards. They will make two 3-digit numbers from the card as shown below.

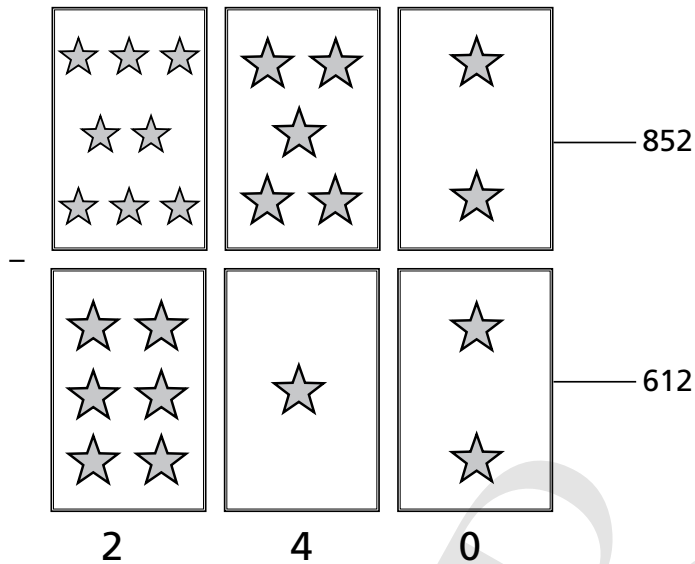

Students will subtract the number and write their answer below the two lines of cards. Once the students understand the concept thoroughly, let them have enough practice of both concrete objects and numbers. Then they are given number (and word) problems to solve on their own. With time and practice, in an identical manner, students are taught conversion of hundreds to tens as well.

OXFORD UNIVERSITY PRESS

4

Multiplication



Suggested Time Frame

8 periods



Learning Curve

The students are familiar with addition and repeated addition. They learnt multiplication of 1-digit numbers. They also learnt that multiplication is a form of repeated addition. They learnt skip counting using the number line. Here, they will learn multiplication of 2-digit and 3-digit numbers with 1-digit numbers.



Real-life Application

The multiplication facts can be easily identified when we create arrays. Arrays can be found everywhere in real life around us. They are a fantastic starting point for noticing and describing multiplication (and therefore division) facts. For example:

- drawer units
- egg boxes
- floor tiles
- wire fencing
- pictures displayed on a wall
- marching soldiers
- chocolate chunks in a bar
- people sitting in a theatre, or a stadium



Frequently Made Mistakes

- Not remembering multiplication tables correctly.



Summary of Key Facts

- Multiplication is repeated addition.
- Numbers follow the commutative property with respect to multiplication.



Model Lesson Plan

Topic

Verification of commutative property of multiplication

Duration

40 minutes

Specific Learning Objective

By the end of the lesson, students will be able to compute and verify the commutative property of addition of numbers.

Key Vocabulary

order, commutative, property, and remain.

Resources

Counters

Strategy

Engagement Activity (5 minutes)

Ask students to write the 2 times table.

Main Developmental Activity (20 minutes)

Take 27 counters and arrange them by placing 9 counters in a line and making 3 such lines. Ask the students how many counters there are. Ask the students to calculate the total number of counters, converting it into multiplication language. It will become 3 multiplied by 9 equals 27.

The above activity shows $9 \times 3 = 3 \times 9 = 27$

This implies that the result of 9×3 and 3×9 are the same, irrespective of the order of the numbers.

Write a few sums on the board, like 2×6 , 3×9 , 2×5 , and 9×8

Ask them to copy down these sums in their notebooks and write each sum interchanging the position of the numbers. Then find the product (it will be same every time). Tell this property of numbers is called the commutative property of numbers.

5

Division



Suggested Time Frame

8 periods



Learning Curve

Students are familiar with multiplication. Division can only be understood if there is a sound knowledge of multiplication to build on, and if students have adequate practical experience in this area. Unknowingly, students have plenty of division activity in their everyday lives. Any process that involves sharing equally is, after all, a form of division. They will learn to divide using a number line, times tables, and the long division method.



Real-life Application

Division is frequently used in our daily life. We divide:

- the people in groups.
- money among people.
- a piece of ribbon, cloths, and rope etc into equal parts.
- money when budgeting.
- equal number of toys among siblings.



Frequently Made Mistakes

- Make errors due to not remembering tables.
- Confuse the division sign with addition sign and add the divisor.
- Get confused between dividend and divisor.



Summary of Key Facts

- Division can be described as repeated subtraction.
- Division means the grouping, sharing, and dividing of a set of objects equally.
- Dividend, divisor, quotient, and remainder are special terms associated with division.
- Division does not follow the commutative property of numbers.



Model Lesson Plan

Topic

Division using times table.

Duration

80 minutes

Specific Learning Objectives

By the end of the lesson students will be able to divide a number using times tables.

Key Vocabulary

divide, share, group, equally, dividend, divisor, quotient, and remainder

Resource

Times table chart

Strategy

Engagement Activity (10 minutes)

Ask the students to develop a times table of a number of their own choice. Now tell them that division can be performed using the times table. They should be encouraged to learn their times table by heart, so that division of numbers would become an easy task for them.

Main Developmental Activity (40 minutes)

Recall some multiplication facts, for example $3 \times 5 = 15$ and $5 \times 3 = 15$

$$15 \div 3 = 5 \text{ and } 15 \div 5 = 3$$

With the help of the times table explain the method to find the quotient.

1	2	3	4	5
2	4	6	8	10
3	6	9	12	15
4	8	12	16	20
1	2	3	4	5
6	12	18	24	30
7	14	21	28	35
8	16	24	32	40
9	18	27	36	45
10	20	30	40	50

$$36 \div 4 = 9$$

$$36 \div 9 = 4$$

$$20 \div 4 = 5$$

$$20 \div 5 = 4$$

Explain to the students that to find $36 \div 4$ and $36 \div 9$, they first find the number 36 in the grid, then they will go vertically upward and horizontally to left of this number. They will find 9 and 4. It means $36 \div 4 = 9$ and $36 \div 9 = 4$.

Similarly, they can proceed for $20 \div 4 = 5$ and $20 \div 5 = 4$.

6

Fractions



Suggested Time Frame

8 periods



Learning Curve

Students have a fair idea about fractions much before they come to school. They are asked time and again to share a chocolate bar equally with their siblings—if there is just one other sibling then each gets half. If there are three other siblings, each gets half of a half, i.e. a quarter.

Activities involving fractions ($\frac{1}{2}$ and $\frac{1}{4}$) increase both their visual and analytical skills.

Students work with a variety of shapes and quantities, such as a net bag full of 10 marbles or 20 mints, etc.



Real-life Application

We can find fractions everywhere around us. Slices of a bread, cake, and pizza are very common examples. Fractions are used, such as $\frac{1}{2}$ glass water, $\frac{1}{4}$ spoon spices, $2\frac{1}{2}$ glasses of milk, and $\frac{1}{3}$ cup of flour etc. In time, we say half hour and quarter hour.



Frequently Made Mistakes

- Getting confused when writing the numerator and denominator in the proper place.
- Matching fractions with shapes.



Summary of Key Facts

- There are proper, improper, and mixed fractions.
- Unit fraction has 1 in the numerator.
- Equivalent fractions are obtained by multiplying or dividing the numerators and denominators with the same number.



Model Lesson Plan

Topic

Learning one-third and more fractions.

Duration

80 minutes

Specific Learning Objective

By the end of the lesson students, should be able to recognise and write unit fractions and other fractions which are not unit fractions.

Key Vocabulary

fraction, equal parts, divide, shape, one-third, and unit fraction

Resources

Two big circular cut-outs, A pair of scissors, small circular cut-outs counted as per the number of students in the class.

Strategy

Engagement Activity (10 minutes)

Distribute small circular cut-out to each child. Ask half of the rows to divide it into halves and half of the rows in quarters using scissors. Ask them to show their half and quarter pieces, then reinforce halves and quarters by comparing the shapes.

Main Developmental Activity (30 minutes)

Hold the big circular cutout and show it to class. Fix it on the board and asking for their attention divide the circle in three equal parts with a pencil and a ruler. Shade one part of the circle. Ask the students that from three equal parts what will be the fraction of shaded part. Recall that $\frac{1}{2}$ and $\frac{1}{4}$ are the fractions obtained from two and four equal parts of the shapes. So when we have three equal parts, the shaded fraction will be $\frac{1}{3}$. Tell them when we take one part out of more than one equal parts, these fractions are known as unit fraction. This concept can be extended to any number of shaded parts from equal parts of a shape. Divide the other big circle into eight equal parts as done previously and shade three parts of it. Ask the students what the fraction will be. It will be $\frac{3}{8}$. Reinforce the learning by shading different number of parts.

7

Measurement: Length, Mass, and Capacity

Length



Suggested Time Frame

6 periods



Learning Curve

Students have worked with long, longer and longest; short, shorter and shortest in Class 1. They are also familiar with terms that define measurement in terms of length, such as metres of cloth, height of a child, length of the road to school, and the tallest building in the world.



Real-life Application

Length is an important and basic unit of measurement used in our daily life found all around us.

Length is used in measuring distance. It is measure in metres and kilometer. Length can be measured as:

- The distance from your house to the grocery store, your uncle's house, or the nearest park are.
- The height of a tree, a building, wall, peoples, mountains, and hills etc.
- Games like cricket, hockey, badminton, tennis, and football are very popular among the people. The length of the cricket pitch, length and breadth of the tennis and badminton courts, and football grounds are measured in metres.



Frequently Made Mistakes

- Incorrectly measuring and reading the length while using the metre rule.
- Usage of incorrect units.
- Inappropriate usage of units with the objects.



Summary of Key Facts

- The length of something is the distance between the two ends.
- The length of something can be measured in metres, centimetres, and millimetres.
- Short means of small length.
- Long means having big length.
- Short and long are opposites.
- Length is also a property of time. An amount of time has a length.



Model Lesson Plan

Topic

Addition of units of length (m, cm)

Duration

80 minutes

Specific Learning Objective

By the end of the lesson, students will be able to add the length of objects measured in metres and centimetres both.

Resources

A metre rule, glue or jam clips, and two pieces of ribbons of different lengths and colours.

Key Vocabulary

length, distance, ruler, centimetre, metre, units, and measure

Strategy

Engagement Activity (10 minutes)

Ask the students to measure the length of their lunch boxes in cm. Now ask every two students sitting on the same desk to add the lengths of their lunch boxes on a piece of paper. Take the feedback by asking the sum from each desk.

Main Developmental Activity (25 minutes)

Show them two different colour ribbons and tell them that you are going to measure them separately. Take the metre rule and measure it in front of the students. Say the length is 1 m and 30 cm. Write this measurement on the board. Now take the other piece, repeat the same procedure, say the length is 1m 50 cm, write the measurement on the board. Now tell them that it is easy to find the addition of lengths which have both the units m and cm. Write the two quantities on the board vertically. Tell them, first we add cm and write the total under cm. Then add the metres and write the total

under m. The result will be the total length of two ribbons. At this level total number of centimetres should not exceed or be equal to 100.

Now join the two pieces with some glue or jam clips. Measure the length of the joined ribbon. The length will be equal to the length calculated on the board. A little difference in the length may be due to the overlapping of the ribbons to join them.

Mass



Suggested Time Frame

6 periods



Learning Curve

Students are familiar with many words which indicate mass. They have heard in their daily-life experiences people talking about kilos of fruits and grams of chocolates, butter, etc. They are even familiar with words, such as heavy and light from Grade 1. Slowly, students discover that the lighter object is not necessarily the smaller one.



Real-life Application

In the old days, people compared the mass of objects by lifting them in their hands. Students experience this everyday when they carry their school bags, pick up their textbooks and lunch boxes, etc. They understand that a school bag is heavier than a lunch box. Charts and a story about astronauts going to the Moon make information interesting. On the surface of the Moon everything weighs less than it does on our planet, Earth.

- We buy vegetables, fruit, lentils etc.
- use different masses of ingredients when cooking and baking different foods.
- mass changes as a child grows into an adult.



Frequently Made Mistakes

- Using inappropriate units for the objects of different weight.
- Making mistakes when adding or subtracting masses with different units.
- Not taking care of the same units while adding and subtracting.



Summary of Key Facts

- Kilogram and gram are the fundamental units of mass.
- Every object has mass.
- The mass of objects can be converted from bigger units to smaller units and vice versa.



Model Lesson Plan

Topic

Using standard weights (grams)

Duration

80 minutes

Specific Learning Objective

By the end of the lesson, students will be able to use standard gram weights.

Key Vocabulary

Standard weights weigh, kilo, kilogram, and gram

Resources

Weights of 500 g, 200 g, 100 g, 50 g, and 10 g. A chart paper with pictures of a tiger, an insect, a book, and a box of milk packs.

Strategy

Engagement Activity (10 minutes)

Paste the chart on the board, write the approximated mass of a tiger (400 kg), a book (500 g), an insect (1 kg), and a box of milk packs (3 kg). Ask the students to identify which of the are not reasonable. Discuss their answer for a few minutes, coming to the final answer, that an insect cannot be as heavy as 1 kg.

Main Developmental Activity (30 minutes)

Now show them 500, 200, 100, 50, and 10 gram weights. Distribute the weights in the class to feel the heaviness. Allow the students to exchange weights so that every students gets the opportunity to experience all different standard mass. Write the names of a few objects on the board and ask them to tell the approximate mass of the objects.

Capacity



Suggested Time Frame

4 periods



Learning Curve

Students have a fair idea about capacity by playing with different containers, filling them with sand, clay or water. Empty and half-full.

Phrases, such as a bucketful of water, a spoonful of medicine, a cupful of hot chocolate, etc. In this Unit, situations such as the petrol tank of a car gets 20 litres of petrol in it at

the petrol pump, the bathtub is filled with 50 buckets of water when there is a water shortage and a bottle has 1 litre of soda, etc. are discussed. Students are also taught to compare capacities like, will a narrow, tall glass hold more water than a flat, wide plate? With practical work students understand that the word 'capacity' refers to the amount of liquid a container can hold.



Real-life Application

Capacities of different objects is measured in our daily lives. They are measured in millilitres and litres. For instance,

- Doctors recommend 8 glasses of a water a day which is equal to about 2 litres.
- If a car's fuel tank holds 25 litres of petrol, it means the capacity of the tank is 25 litres.
- Measuring cups and spoons are used when cooking and baking recipes for accuracy.



Frequently Made Mistakes

- Difficulty in estimating the capacity of different sized containers.
- Tendency to recall that 1000 ml is equal to 1 litre.
- Making mistakes when adding and subtracting same and different units.
- Mixing units when measuring capacities.



Summary of Key Facts

- 1000 ml = 1 litre.
- Big quantities of liquid are measured in litres.
- Small quantities of liquid are measured in millilitres.
- Different capacities can be measured using non-standard units, such as jugs, glasses, cups, etc.



Model Lesson Plan

Topic

Comparing and Estimating capacities

Duration

80 minutes

Specific Learning Objectives

Estimate the capacities of different objects and compare them to one another.

Key Vocabulary

capacity, containers, and millilitres.

Resources

Beakers and flasks of different capacity used in the science laboratory, 10 ml and 30 ml empty washed medicine bottles, an empty litre bottle, a jug of water.

Strategy

Engagement Activity (10 minutes)

Show them two medicine bottles, one 10 ml and the other 30 ml in capacity. Ask the students how many 10 ml bottles will fill the 30 ml bottle. Take the feedback and explain if there is any ambiguity.

Main Developmental Activity (30 minutes)

Arrange a table with containers of different sizes and put estimation cards in front of different containers. Ask the students to guess the capacity of the container and write it down on the cards. Later, ask them to fill the containers and write down the actual capacity of the containers.

OXFORD
UNIVERSITY PRESS

8

Time



Suggested Time Frame

6 periods



Learning Curve

Students have a fair idea about time, long before they come to school—wake-up time, school time, lunch break and meal time, etc. They have heard their parents or teachers speak about summer vacations, monsoon floods, and winter clothes.

Students best understand time if it is taught to them in relation with their own experience. They know that there are seven days in a week and are familiar with their names. They also know that there are an average 30 days in a month and 12 months in a year. With the passage of time, they get familiar with dates of the month in association with the days of the week and the names of the months.

With greater exposure and practice, they are able to read the clock face and are able to tell the time accurately.



Real-life Application

Time is an important aspect of our daily life. We use time to stay organised and maintain our every day functions. It is measured in seconds, minutes, hours, days, weeks, months, and even years.

- Students can make a timetable for their daily activities. For example, breakfast time, school time, break time, lunch time, play time, reading time, and sleep time.
- We find time on invitation cards, doctor's appointments, and meeting slips etc.
- A program list of a conference or any event.
- Important national and universal days and dates.



Frequently Made Mistakes

- Get confused in the hour and minute hand of the clock.
- Get confused when calculating time in five-minute intervals.



Summary of Key Facts

- There are 24 hours in a day, 60 minutes in an hour, and 60 seconds in a minute.
- There are 12 months in a year, 4 weeks in a month, and 7 days in a week.
- There are 365 days in an year.
- From midnight till noon, "a.m." is written with the time and from noon till midnight, "p.m." is written with the time.



Model Lesson Plan

Topic

To tell time in five minute intervals

Duration

80 minutes

Specific Learning Objective

By the end of the lesson, students will be able to tell the time in hour and minutes.

Key Vocabulary

hour, minute, interval, and clock.

Resources

A big clock drawn on a coloured chart paper, showing minute and hour hands cut in strips of chart paper attached in the centre of the clock using a common pin to move freely.

Strategy

Engagement Activity (10 minutes)

Pair up two students together. Write the topic Time on the board and ask students to discuss about time with their partners. Guide them to talk about their daily routine. They can share their play time, bed time, and story time, etc. After 5 minutes ask a few students to share their ideas with other students.

Main Developmental Activity (30 minutes)

Explain to students that they will be learning about five minutes interval time. Reinforce the learning of exact time and half past time. Display the big clock on the board. Move the hands of the clock, telling the time with hours and minutes. Tell them that there are five minutes from one digit to the next digit and we start counting from 12. So from 12 to 1 it is five minutes and from 1 to 2 it is again five minutes. Therefore from 12 to 2 will make ten minutes. In the same way we keep on adding five minutes every time. As repeated addition is a form of multiplication, so minutes can be found by checking the placement of the big hand and multiplying the number with 5.

Move the hands of the clock onto different numbers and ask the time.



Suggested Time Frame

6 to 8 periods



Learning Curve

Students are familiar with 3-D and 2-D shapes from their daily life. They have seen and held objects, such as a ball (a sphere), a dice (a cube), a toothpaste box or a lunch box (a cuboid), an ice cream cone (a cone), etc.

They have also felt the flatness of shapes, such as a floor tile (a square) or a windowpane (a rectangular), a round plate (a circle), a kite (a quadrilateral) and the four parts of a kite (triangles). They have a visual idea of what each looks like, but often get confused with names. At this level their knowledge of shapes takes a slightly more formal shape.



Real-life Application

We have different sized and shaped objects around us. We can see triangles, squares, and circles everywhere. Some of these shapes have length, breadth, and height and are 3-D or three-dimensional objects. For example houses have length, breadth, and height and are 3 D objects. Others, like a sheet of paper, can be imagined to have a length and a breadth only. Such objects are 2-D or dimensional objects.



Frequently Made Mistakes

- Make mistakes when identifying and differentiating faces and vertices of 3-D shapes.
- Have difficulty recalling the names of the shapes.



Summary of Key Facts

- The 3-D shapes are composed of three dimensions. They have faces, edges, and vertices.

- A cube, rectangular prism, sphere, cone and cylinder are the basic three dimensional shapes we see around us.
- Some 3-D shapes have flat faces, some have curved faces, and some have both.
- The 2-D shapes are composed of two dimensions i.e. length and breadth.



Model Lesson Plan

Topic

3-D Shapes

Duration

60 minutes

Specific Learning Objective

By the end of the lesson, students will be able to identify the faces, edges, and vertices of 3-D shapes.

Key Vocabulary

cube, cuboid, vertex, faces, edges.

Resources

Wooden geometrical solids

Strategy

Engagement Activity

Divide the class into groups and let each group list the name of the things that they can find in a cube and cuboid shape. Ask them to write as many things as they can.

Main Developmental Activity (25 minutes)

Use wooden geometrical solids (easily available in the market) for introducing the shapes. Let students explore different 3-D shapes. Ask the students what are the similarities and differences between each shape. The cube looks the same when it is turned because every face is a square. Cuboids can be laid down or stood up on the longer or shorter faces. Let students count the total number of faces, edges, and vertices on both the cube and cuboid. Ask them how many corners and faces there are in a cube.

MATHS WISE 2

Lesson plans to be used in conjunction with the
Maths Wise book series.

OXFORD
UNIVERSITY PRESS

UNIT 1

REVIEW AND ASSESS 1

Teaching objectives

- to revise concepts and skills learnt in the previous year
- to revise ordinal and cardinal numbers
- to practice sequences as taught earlier
- to recall shapes learnt earlier
- to recall concepts of money, length, and mass

Teaching materials:

- additional worksheets

Learning Activity

Lesson 1: Fill in the missing numbers. Write more or less.

40 minutes

Ask the children to count from 1 to 100 in groups or by taking turns.

Activities are based on the children comparing numbers up to 20. They could compare:

- sets of objects such as pencils, erasers and rulers
- numbers written on the board, in numerals and in words
- a group of children wearing glasses and a group who are not

Task: Children attempt pages 2 and 3.

Lesson 2: Count each set of objects..., Beginning at the bottom of each ladder...

40 minutes

Refer to lesson 1 for counting practice. Give the children objects to count; they can also count objects in pictures, or around them in the playground or the classroom.

Task: Children attempt pages 4 and 5.

Lesson 3: Fill in numbers ..., Solve these:

40 minutes

Ask the children to count from 1 to 100 and then count backwards from 100 to 0. Explain the terms ascending and descending order. Write a few numbers on the board and ask the children to arrange them in ascending and descending orders.

It is important to explain that numbers written in ascending order are in exactly the opposite order to those written in a descending order.

For example:

9, 22, 50, 61, 78, 91: numbers are in ascending order

91, 78, 61, 50, 22, 9: same numbers in descending order

Recall concepts of addition and subtraction. Work some examples on the board.

Task: Children attempt pages 6 and 7.

Lesson 4: Game**40 minutes**

Revise familiar shapes: show the children 3D shapes and ask them to identify them. Draw several shapes on the board and ask the children to count the different types of shapes drawn.

Even though the illustrations on page 8 of MW 2 are all of 3D shapes, a similar activity with 2D shapes is also useful. This exercise should focus on grouping together objects of the same shape (cubes, cuboids, cones, balls, and ovoids) but of different sizes.

Task: Children attempt page 8.

Additional resources

At the end of the guide are additional worksheets 1, 2, and 3. Use them for reinforcement.

OXFORD
UNIVERSITY PRESS

UNIT 2

WHOLE NUMBERS

Ordinal numbers

- i. Write ordinal numbers from first to twentieth
- ii. Write numbers 1-100 in words

Numbers up to 100

- i. Read numbers up to 999
- ii. Write numbers up to 999 as numerals
- iii. Recognise the place value of a 3-digit number
- iv. Identify the place value of a specific digit in a 3-digit numbers
- v. Compare 2-digit numbers with 3-digit numbers (hundreds, tens and ones)
- vi. Compare 3-digit numbers with 3-digit numbers (hundreds, tens and ones)
- vii. Count backward ten steps down from any given number
- viii. Arrange numbers up to 999, written in mixed form, in increasing or decreasing order
- ix. Count and write in 10s (e.g. 10, 20, 30, ...)
- x. Count and write in 100s (e.g. 100, 200, 300, ...)
- xi. Identify the smallest/largest number in a given set of numbers
- xii. Recognise that 1000 is one more than 999 and the first 4-digit number

Teaching materials:

- number squares with numbers from 1 to 100
- number lines drawn on the floor
- transparent packets with 10 or 12 marbles in each

Learning activity:

Lesson 1: Ordinal numbers

40 minutes

PLEASE remember that the words ORDINAL and CARDINAL are for you only, not for the children. The concept of the size of a set (cardinal number) and the position of a number in a sequence (ordinal number) are more easily explained by practical and board work than by using the actual terms.

These pages revise ordinal numbers. They should be easily remembered when placed in the order taught in the previous books. They were introduced as positions. Children also learn to spell the ordinal positions such as first, second, and third

Jumble up the letters of FIRST as RSTIF, SECOND as DONSCE and THIRD as DIRTH ... and so on. Ask the children to find the correct ordinal numbers. Introduce the word anagram.

Ask the children to stand on a numbered line. Each child steps forward when his or her name is called out, announces his or her position, and hops ahead by that many steps. The same may be repeated with steps taken backwards.

Make a chart showing the planets around the Sun, with the name of each planet written below it. The different sizes of the planets should be clearly shown. Point out the positions of planets around the Sun using words like first, second, third, nearest, and farthest. The children should make a list of the planets, starting with the 1st planet, closest to the Sun, and going outwards.

Then ask the children to write the names of the planets in ascending or descending order according to size. They may require some assistance in working this out. (If this is too difficult, leave it for the end of the year.)

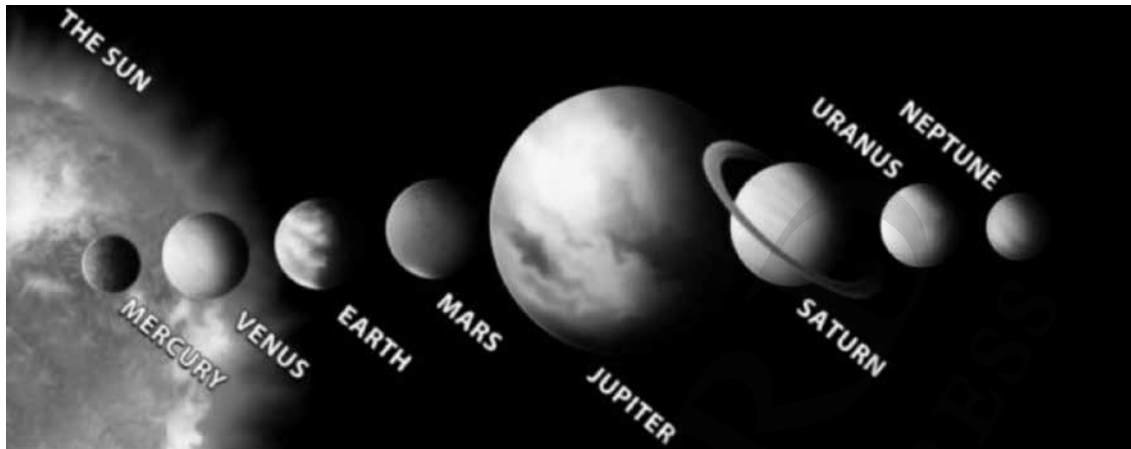

Task: Children attempt pages 10 and 11.

Lesson 2: Ordinal numbers; number names (continued)

40 minutes

The stairs of a multi-storied building are useful to reinforce ordinal numbers. The lowest floor is referred to as the ground floor (not the first floor). In a lift the ground floor is denoted by 0 or G. GROUND FLOOR, FIRST FLOOR, SECOND FLOOR, THIRD FLOOR, and so on.

A wall chart recording the different activities during the weeks of a year is an interesting activity: 1st week, 2nd week, and so on.

Take the children outside to play this game. 10 positions, 1st to 10th, are marked in a row on a number line on the ground. Each child picks a random ordinal number card (1st, 2nd, 3rd, 4th to 10th) from a basket and hangs it on the back of another child.

Ahmed sees Salma with 3rd on her back; he shows 3 fingers and Salma stands in the 3rd position on the number line. Salma sees Julie with 10th on her back, and shows all 10 fingers to Julie. Julie goes to the 10th position on the line. After a little guidance, and hesitation, all children find their positions on the line.

This game can be played with positions from 1st to 20th or 41st to 60th and so on. Instead of a straight line, a circle with numbers written round the circumference can be used for variety.

Task: Children attempt pages 12 and 13.

Lesson 3: Cardinal numbers; ordinal numbers (continued)

40 minutes

Revise the number names and their spellings learned in the previous year. In the age of computers, handwriting is often neglected. Encourage the children to write the number names frequently in a good cursive style. A good deal of practice is required to consolidate the spellings. The concept of place value also needs to be revisited with some activities. The children also need to be introduced to the hundreds place value.

Make number squares with numbers from 1 to 100 and 1st to 100th.

Cardinal number square:

1	2	3	4	5	6	7	8	9	10
11	12	13	14	15	16	17	18	19	20
21	22	23	24	25	26	27	28	29	30
31	32	33	34	35	36	37	38	39	40
41	42	43	44	45	46	47	48	49	50
51	52	53	54	55	56	57	58	59	60
61	62	63	64	65	66	67	68	69	70
71	72	73	74	75	76	77	78	79	80
81	82	83	84	85	86	87	88	89	90
91	92	93	94	95	96	97	98	99	100

Ordinal number square

1 st	2 nd	3 rd	4 th	5 th	6 th	7 th	8 th	9 th	10 th
11 th	12 th	13 th	14 th	15 th	16 th	17 th	18 th	19 th	20 th
21 st	22 nd	23 rd	24 th	25 th	26 th	27 th	28 th	29 th	30 th
31 st	32 nd	33 rd	34 th	35 th	36 th	37 th	38 th	39 th	40 th
41 st	42 nd	43 rd	44 th	45 th	46 th	47 th	48 th	49 th	50 th
51 st	52 nd	53 rd	54 th	55 th	56 th	57 th	58 th	59 th	60 th
61 st	62 nd	63 rd	64 th	65 th	66 th	67 th	68 th	69 th	70 th
71 st	72 nd	73 rd	74 th	75 th	76 th	77 th	78 th	79 th	80 th
81 st	82 nd	83 rd	84 th	85 th	86 th	87 th	88 th	89 th	90 th
91 st	92 nd	93 rd	94 th	95 th	96 th	97 th	98 th	99 th	100 th

Work with little counters which fit in the squares.

Questions such as these are useful:

1. What comes before 14 (or 14th)?
2. What comes after 28 (or 28th), 39 (or 39th)?
3. What number is written 2 places before 27 (or 27th)?
4. What number is 10 places after 39 (or 39th)?
'10 after 39' changes the tens digit: 39 becomes 49 (10 more always goes to the next line.)

'2 before 27' decreases the units digit by 2; 27 becomes 25. The new number may be in the same line or in the previous line. For example, 2 less than 31, i.e. 29 goes into the previous line.

Increasing a number may also give the resultant number in the same line or the next line. 5 after 23 is 28, which is in the same line; 1 after 30, is 31, which is in the next line.

Task: Children attempt pages 10 to 15.

Lesson 4: Place value (up to 3 digits)

40 minutes

At this level children are familiar with 1 rupee coins, 10 rupee notes, and 100 rupee notes. Using these is an excellent way to introduce the concept of 3-digit numbers. Collect several Re.1 coins and Rs 10 and Rs 100 notes. Set up a shop where 3-digit prices of toys are marked. Children do shopping with pretend money.

Practical work with cubes (to represent units), rods of 10 cubes (to represent tens) and a slab of 10 rods (to represent a hundred) is essential to introduce the value of 100, and is useful for addition and subtraction later on.

Work with numbers such as:

1 more than 99; 1 more than 100, using paper money or rods and slabs.

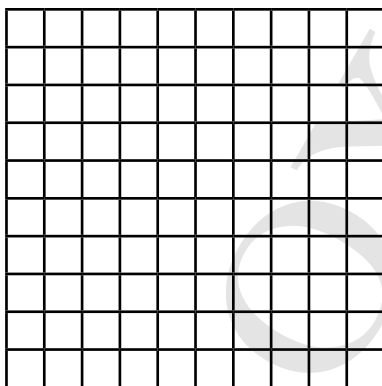

Hundreds
 10×10



Tens
 $10 = 10 \times 1$



Ones
1

Once the 3-digit concept is clear, the children can shop for items marked with 3-digit prices, e.g. Rs 153 or Rs 216.

'Which number is 2 tens more than 340?' Show this on the number square.

If there is a number square on the wall, the children will find it very simple to find the answer, even if they do not remember the number sequence.

Arrange 3 tables in the classroom and label them ONES, TENS, and HUNDREDS. On each table, place small cards numbered from 0 to 9. Call the children one at a time to each table. Starting with ones and tens, ask each child to choose one card from each table and show them to the class. Two numerals are shown, e.g. 7 TENS and 5 ONES. They call out the number 75. Many 2-and 3-digit numbers can be formed in this manner.

Task: Children attempt pages 16 to 19.

Lesson 5: Place value (continued)

40 minutes

Practical work with paper money up to Rs.1, 000 and wooden manipulatives up to 1,000 are easy to understand once the 3-digit concept has been successfully understood.

Ask one child to call out a number, of three digits e.g. 367. Ask another to name and spell it aloud: three hundred and sixty-seven. Ask the class to name the numbers before and after 367.

Work with numbers such as 299, 399, 499 999 and ask the children to name the numbers before and after each: 298, 299, 300: 998, 999, 1000

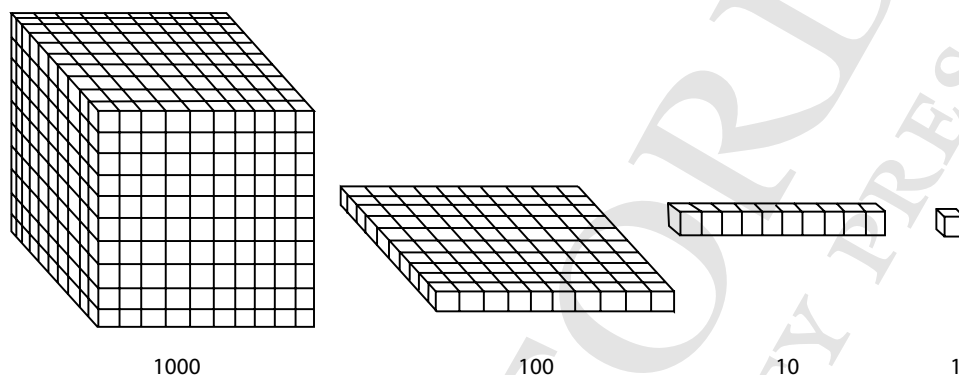

Show this with paper money and cubes. It is too early to go into 4-digit number names.

Task: Children attempt pages 20 and 21.

Lesson 6: Place value (continued)

40 minutes

You need a large wooden dice for this game. Draw the table below on the ground in the play area.

HUNDRED	TENS	ONES
9	9	9
8	8	8
7	7	7
6	6	6
5	5	5
4	4	4
3	3	3
2	2	2
1	1	1
0	0	0

Sara

Beenish

Mushtaq

Select 3 children at a time, for example, Sara, Beenish, and Mushtaq. Let each stand on 0 at the bottom of each column.

Ask Sara to begin with the hundreds. She rolls the dice; it lands on 6 so she moves to 6 and says, 'six hundred.'

Beenish then rolls the dice for the tens column. It lands on 2 so she moves to 2 and says, 'Twenty.' Finally Mushtaq repeats the process for the ones. The dice lands on eight so he moves to 8 and says, 'Eight.'

You call out the number, six hundred and twenty-eight, and write 628 in large numerals and words on the board. Repeat the exercise with different numbers and different groups of children.

Task: Children attempt page 22.

Additional resources

At the end of the guide are additional worksheets 4, 5, 6, and 7. Use them for reinforcement.

OXFORD
UNIVERSITY PRESS

Addition of 2-digit numbers (with carrying)

- i. Add ones and ones
- ii. Add ones and 2-digit numbers with carrying
- iii. Add 2-digit numbers and 2-digit numbers with carrying
- iv. Solve real life number stories, involving addition of 2-digit numbers with carrying

Addition of 3-digit numbers (without carrying)

- i. Add 3-digit number and ones without carrying
- ii. Add 3-digit number and 2-digit number without carrying
- iii. Add 3-digit number and 3-digit number without carrying
- iv. Solve real life number stories involving addition of 3-digit numbers without carrying

2.3. Addition of 3-digit numbers (with carrying)

- i. Add 3-digit number and 1-digit number with carrying of tens and hundreds
- ii. Add 3-digit number and 2-digit number with carrying of tens and hundreds
- iii. Add 3-digit numbers with 3-digit numbers with carrying of tens and hundreds
- iv. Solve real life number stories involving addition of 3-digit numbers with carrying of tens and hundreds

Subtraction of 2-digit numbers (with borrowing)

- i. Subtract 1-digit number from 2-digit numbers with borrowing
- ii. Subtract 2-digit numbers from 2-digit numbers with borrowing
- iii. Solve real life number stories of subtraction of 2-digit numbers with borrowing

Subtraction of 3-digit numbers (without borrowing)

- i. Subtract 1-digit from 3-digit number without borrowing
- ii. Subtract 2-digit number from 3-digit number without borrowing
- iii. Subtract 3-digit numbers from 3-digit numbers without borrowing
- iv. Solve real life number stories of subtraction up to 3 digits without borrowing

Subtraction of 3-digit numbers (with borrowing)

- i. Subtract 1-digit number from 3-digit number with borrowing
- ii. Subtract 2-digit number from 3-digit number with borrowing
- iii. Subtract 3-digit number from 3-digit number with borrowing
- iv. Solve real life number stories of subtraction up to 3 digits with borrowing
- v. Analyse simple situations identifying correct operation of addition and subtraction with carrying/borrowing in mixed form

Multiplication

- Recognise multiplication as repeated addition (e.g. $2+2+2=6$ is equivalent to 3 times $2 = 6$ and $3 \times 2 = 6$) and use multiplication symbol “ \times ”
- Complete number sequences in steps of 2,3,4,5 and 10 (e.g. in steps of 2 the sequence is expressed as 2,4, 6...)
- Develop multiplication tables of 2,3,4,5 and 10 till the multiplication of 10×10
- Multiply numbers within multiplication table
- Write number sentence for multiplication from the picture such as $2 \times \square = 6$
- Solve number stories on multiplication up to 1-digit numbers

Division

- Recognise and use division symbols \div
- Recognise division as successive subtraction
- Divide numbers within the multiplication tables with remainder zero
- Solve number stories involving division up to 1-digit numbers

Addition, Subtraction, Multiplication and Division

- Solve real life situations (using Pakistani currency as well) involving addition, subtraction, multiplication, and division. Give reasons for choosing the correct operation

Teaching materials:

- beads
- egg trays
- pencils
- number grid
- blocks of ones, tens, and hundreds

Learning activities

Lesson 1: Addition

40 minutes

Math Wise 2 lays great stress on number operations. The children work on each operation in great detail. The concepts of ‘carrying over’ and ‘borrowing’ are made clear. A lot of extra work is necessary. Show how numbers are arranged vertically. Introduce the concept by adding ones that add up to more than ten.

Task: Children attempt page 28 and 29.

Lesson 2: Addition of 2-or 3-digit numbers

40 minutes

Start by revisiting the idea of representing numbers as ones, tens, and hundreds. Give each child a set of blocks, and ask them to form numbers using the blocks. For example, 234 can be represented as 2 hundreds, 3 tens, and 4 ones. One child may represent it as 2 hundreds and 34 units, or 23 tens and 4 ones, or even 234 ones. At this point, consolidate the idea of groups of ten. A group of 10 ones makes 1 ten, and a group of 10 tens makes 1 hundred. Repeat this exercise until the children are comfortable with 3 digit numbers.

Now add the numbers in the hundreds column.

H	T	O
#####	#####	
2	3	4
+ 1	6	7

4	0	1

2 hundreds and 1 hundred and 1 hundred (carried over from the tens) makes 4 hundreds.

The final answer is 4 hundreds, 0 tens and 1 ones, OR 401.

Repeat this exercise several times till the children are comfortable with the idea of carrying over.

As a fun exercise, give each one a worksheet with an illustration such as this.

Each section has a number written on it; each number is the sum of numbers such as these:

$\begin{array}{r} 45 \\ + 38 \\ \hline \end{array}$	$\begin{array}{r} 79 \\ + 11 \\ \hline \end{array}$	$\begin{array}{r} 24 \\ + 64 \\ \hline \end{array}$	$\begin{array}{r} 50 \\ + 50 \\ \hline \end{array}$
---	---	---	---

Ask the children to colour the numbers to be added and the answer in the same colour.

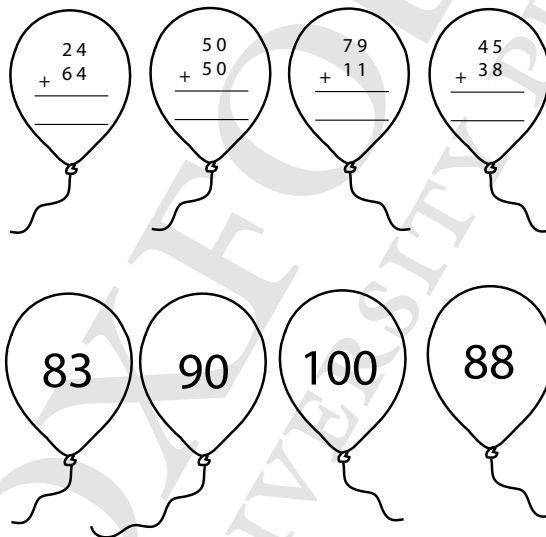

Task: Children attempt pages 29 to 32.

Lesson 3: Addition of 2-and 3-digit numbers (continued)

40 minutes

Squares cut out from a paper grid can be useful in representing O, T, and H. One one is represented by a small square, one ten by a strip of 10 small squares, and one hundred by a large square of 100 small squares. Give out squares, strips, and small squares of paper to groups of children. They can use these to represent numbers.

This diagram represents: $300 + 70 + 7 = 377$ Show the children how to write out the addition problems and represent carrying over.

Hundred

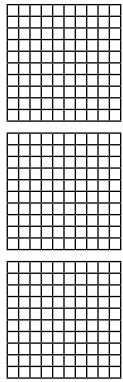

Tens

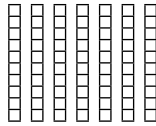

Ones

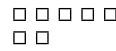

$$300 + 70 + 7 = 377$$

Task: Children attempt pages 32 to 34 and 36.

Lesson 4: Subtraction

40 minutes

Subtraction may be introduced in a similar fashion. For example:

H	T	O
2	3	4
– 1	5	7

Reiterate the concept of groups of 10. Emphasize that addition and subtraction of numbers **MUST ALWAYS** start from the ones digit. (Later, multiplication also starts from the ones column and moves left. Only division starts from the column on the left and moves to the ones.)

Think:
Do I need to regroup?

Think: I can regroup 1 ten as 10 ones. Now I can subtract 7 ones from 12 ones and 3 tens from 4 tens. The answer is 15

	Tens	Ones
–	□	□
	5	2
	3	7

	Tens	Ones
	4	12
	5	2
	3	7
	1	5

The mathematical term to use for ‘borrowing’ is ‘regrouping’, but, to make it interesting for the children, a ‘borrowing’ story is fun.

The Ones could not give away 7 from the 4 they had, so they went knocking on the Ten’s door to borrow one ten. One ten opened out to make 10 ones, because Tens can lend only in bundles of 10 ones. The Ones house has 10 (borrowed) + 4 = 14 ones. The Ones house gave away 7 ones, and had 7 ones left.

In the house of Tens, they had 2 tens left, and they had to give away 5 tens. They could not do that, so they went knocking on the Hundred’s door to borrow 1 hundred, or 10 tens. (A Hundreds house has only groups of 10) So, the Tens borrowed 10 tens.

The Tens house had: 10 (borrowed) $+ 2 = 12$ tens. 5 tens were given away from the 12, and there were 7 tens left. In the house of Hundreds, there was 1 hundred left after 1 hundred (or 10 tens) was lent to the Tens house.

1 hundred taken away from 1 hundred, leaves none. That makes 0 hundreds, 7 tens, and 7 ones. The final answer is 77.

OR	H	T	O
	2	3	4
-	1	5	7
	0	7	7

Repeat such examples several times until the children are comfortable with the concepts of 'carrying over' and 'borrowing'. They can then represent this in writing.

Task: Children attempt pages 37 to 39.

Lesson 5: Subtraction of 2 and 3-digit numbers (continued)

40 minutes

Based on last year's work, a chart with these types of numbers will be useful...



$$32 \pm 57 = 89$$

($89 > 32$ and 57 ; and $2 + 7 = 9$... the correct sign is +)

$$69 \pm 43 = 26$$

($9 - 3 = 6$ and $26 < 69$... the correct sign is -)

$$132 \pm 234 = 366$$

($366 > 132$ and 234 , and $4 + 2 = 6$... the correct sign is +)

$$495 \pm 213 = 282$$

($5 - 3 = 2$; and $282 < 495$... the correct sign is -)

Do remember that the concepts of borrowing and carrying over should not be rushed. Take as much time as is needed to consolidate the concept. Do a lot of hands-on activities.

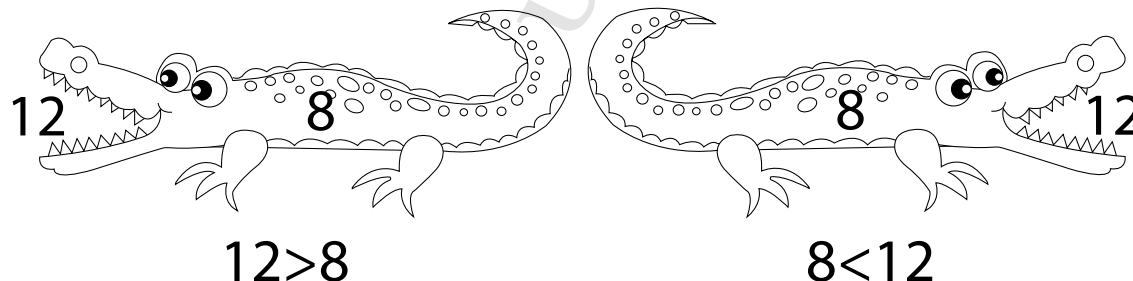

Explain the symbols $>$ than and $<$ than

The story goes ... the greedy crocodile always has his mouth open to eat the bigger number, while the smaller number is already in its stomach.

More worksheets with colouring by working out addition and subtraction sums. Refer to Lesson 2.

Task: Children attempt pages 40 to 42.

Lesson 6: Multiplication

40 minutes

Multiplication is repeated addition. Start with a simple activity. Call 3 children to the front of the class. Call 3 more, then, call 3 more. As they stand together in 3's, call out the total number of children

$$\begin{aligned} \text{III (3)} &= \text{III (3)} && \text{One 3 is 3.} \\ \text{III (3) + III (3)} &= \text{III III (6)} && \text{Two 3s are 6} \\ \text{III (3) + III (3) + III (3)} &= \text{III III III (9)} && \text{Three 3s are 9.} \end{aligned}$$

The children follow the pattern and complete it as far as Ten 3s are 30.

Similar activities may be carried out with pictures of 3 legs of a camera tripod, 3 toes of some birds, or 3-leaf shamrock that is the symbol of Ireland.

- 4 legs of a mammal
- 5 fingers of a hand
- 6 sides of a cell in a beehive
- 7 colours of the rainbow, or days in a week
- 8 legs of an octopus

It is interesting to create number squares for the wall, with multiples of different numbers in different colours: multiples of 2 in red, multiples of 3 in blue, multiples of 4 in green, and multiples of 5 in yellow. Look for the numbers which are multiples of 2 and 3, or 2 and 5 and so on.

Work with crosses like this:

FOR ADDITION:

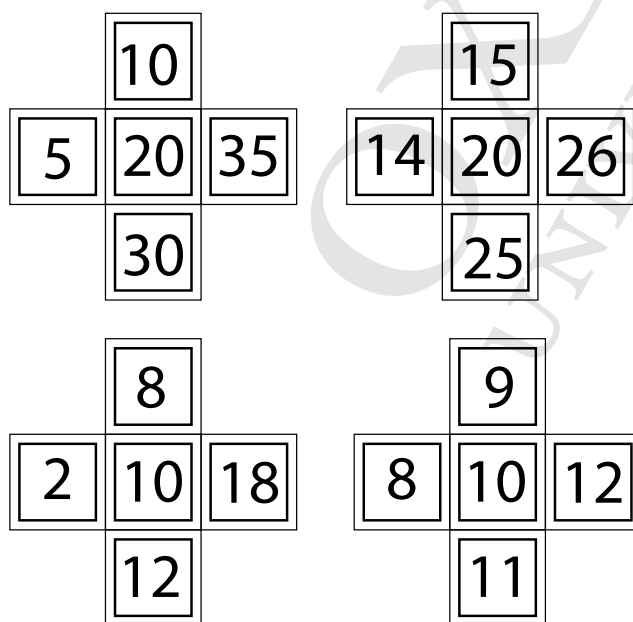

Leave one of the numbers out, and help children to work out the missing number.

Task: Children attempt pages 44.

Lesson 7: Multiplication (continued)**40 minutes**

Even though calculators and mobile phones are used for multiplication, it is important that children memorize the tables. This helps to improve long term and short term memory tremendously.

Help the children make their own multiplication tables and display them in the classroom.

Give the children a grid with numbers from 1 to 100. Ask them to colour numbers in jumps of 2 in red; jumps of 3 in green; jumps of 4 in yellow; jumps of 5 in pink; jumps of 10 in blue. Ask them which numbers are coloured in both red and blue? Which numbers have 3 colours?

(OR use different number squares for different tables)

×	1	2	3	4	5	6	7	8	9	10
1	1	2	3	4	5	6	7	8	9	10
2	2	4	6	8	10	12	14	16	18	20
3	3	6	9	12	15	18	21	24	27	30
4	4	8	12	16	20	24	28	32	36	40
5	5	10	15	20	25	30	35	40	45	50
6	6	12	18	24	30	36	42	48	54	60
7	7	14	21	28	35	42	49	56	63	70
8	8	16	24	32	40	48	56	64	72	80
9	9	18	27	36	45	54	63	72	81	90
10	10	20	30	40	50	60	70	80	90	100

Create a multiplication grid as shown above and display it in the classroom. It is a good aide-mémoire.

Task: Children attempt pages 44 to 51.

Lesson 8: Multiplication (continued)**40 minutes**

Plenty of practice with multiplication exercises is necessary. Refer to the lessons above for practical as well as theoretical exercises.

Task: Children attempt pages 52 to 54.

Lesson 9: Division**40 minutes**

Division is repeated subtraction.

Give a child a bag of 10 pencils and ask him/her to give 2 to one friend in the class. Then, give 2 more pencils to a second friend, 2 to a third friend, and so on until no more pencils remain.

$$10 - 2 = 8 \quad \text{Take 2 out of 10 once: 8 left.}$$

$$10 - 2 - 2 = 6 \quad \text{Take 2 out of 10 twice: 6 left.}$$

$$10 - 2 - 2 - 2 = 4 \quad \text{Take 2 out of 10 three times: 4 left.}$$

$$10 - 2 - 2 - 2 - 2 = 2 \quad \text{Take 2 out of 10 four times: 2 left.}$$

$$10 - 2 - 2 - 2 - 2 - 2 = 0 \quad \text{Take 2 out 10 five times: 0 left.}$$

$$10 - 2 = 8$$

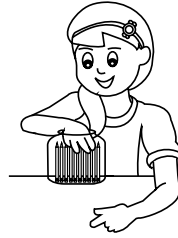

$$10 - 2 - 2 = 6$$

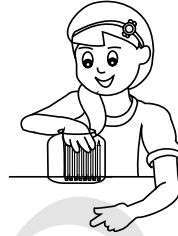

$$10 - 2 - 2 - 2 = 4$$



$$10 - 2 - 2 - 2 - 2 = 2$$



$$10 - 2 - 2 - 2 - 2 - 2 = 0$$



How many friends were given pencils? Explain the process the child followed to distribute the pencils to his/her friends. Explain that this is the opposite of multiplication. Give more examples to explain the fact that multiplication and division are flip sides of a coin. Relate the process to the multiplication tables.

In this case 5 children receive 2 pencils each. Use the notation of division, $10 \div 2 = 5$; the children should learn to write this sign for division.

Repeat this for multiplication, and explain to the class that **JUST AS ADDITION AND SUBTRACTION ARE OPPOSITES OF EACH OTHER, MULTIPLICATION AND DIVISION ARE ALSO OPPOSITES OF EACH OTHER**

Task: Children attempt pages 55 and 56.

Lesson 10: Division (continued)**40 minutes**

Let the children work in groups for this activity. Give each group 12 beads and an egg tray. Ask them to divide the beads equally in the grooves of the tray in all possible ways.

They might do it in the following ways:

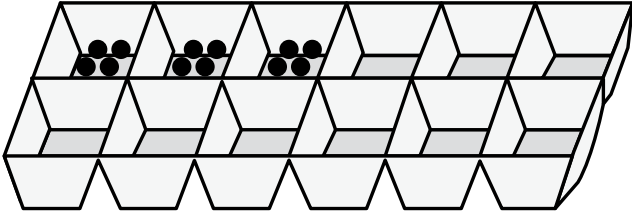

- 4 beads in 3 compartments each
 $3 \times 4 = 12$ Three 4s equal 12 ($4 + 4 + 4 = 12$)
 $12 \div 4 = 3$ 12 divided by 4 equals 3
 $(12 - 4 = 8; 8 - 4 = 4; 4 - 4 = 0)$

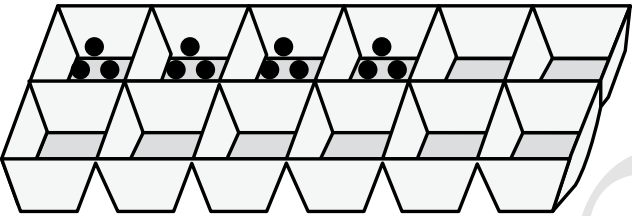

- 3 beads in 4 compartments each ...
 $4 \times 3 = 12$ ($3 + 3 + 3 + 3 = 12$) Four 3s equal 12
 $12 \div 3 = 4$ ($12 - 3 = 9; 9 - 3 = 6; 6 - 3 = 3; 3 - 3 = 0$)
 12 divided by 3 equals 4

- 6 beads in 2 compartments each
 $2 \times 6 = 12$ ($6 + 6 = 12$) Two 6s equal 12
 $12 \div 6 = 2$
 $(12 - 6 = 6; 6 - 6 = 0)$ 12 divided by 6 = 2

- One bead each in 12 boxes
 $12 \times 1 = 12$ ($1 + 1 + 1 + 1 + 1 + 1 + 1 + 1 + 1 + 1 + 1 + 1 = 12$)
 Twelve 1s = 12
 $12 \div 1 = 12$ ($12 - 1 = 11; 11 - 1 = 10; 10 - 1 = 9; 9 - 1 = 8; 8 - 1 = 7;$
 $7 - 1 = 6; 6 - 1 = 5; 5 - 1 = 4; 4 - 1 = 3; 3 - 1 = 2; 2 - 1 = 1;$
 $1 - 1 = 0$)
 12 divided by 1 equals 12

- 12 beads in one compartment
 $1 \times 12 = 12$ ($12 = 12$)
 One 12 equals 12
 $12 \div 12 = 1$ ($12 - 12 = 0$ 12 divided by 12 equals 1)

You need to go over the various aspects of multiplication being the opposite of division for 12 and its various factors, and it will be useful to work with other numbers as well.

A similar activity will help the children understand that there may be more than one way of distributing the beads or pencils. This might happen with the number of stickers someone brings for his class friends, or the balloons that need to be distributed amongst the children attending a birthday party.

The concept is important for the children to understand. Compared to addition and subtraction, multiplication and division are slightly more complex concepts. They need to decide whether a situation calls for repeated addition (multiplication) or repeated subtraction (division), and finally realize that MULTIPLICATION AND DIVISION ARE OPPOSITES OF EACH OTHER.

Work with more numbers:

Two 5's (two groups of 5) OR Five 2's (five groups of 2) AND

From 10, give away 5 each time ($10 - 5 = 5$; $5 - 5 = 0$ twice)

OR from 10, give away 2 each time ($10 - 2 = 8$; $8 - 2 = 6$; $6 - 2 = 4$; $4 - 2 = 2$; $2 - 2 = 0$... 5 times)

Let the children work in groups for this activity.

At Hassan's twelfth birthday, his friends want to place candles at the intersections of the chocolate sticks placed as shown on his beautiful chocolate cake:

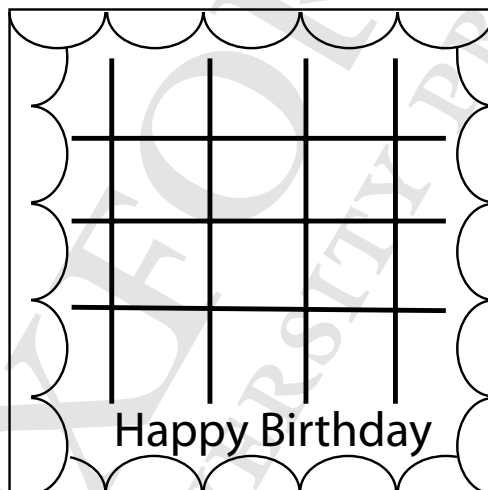

This is a practical representation of the 1st problem above, with beads in an egg tray.

There are 12 intersections, so 12 candles can easily be placed.

$$4 \times 3 = 12 \quad 3 \times 4 = 12 \quad 12 \div 3 = 4 \quad 12 \div 4 = 3$$

Here a couple of practical ways to demonstrate multiplication by 0:

1. 1 horizontal stick with no vertical sticks gives 0 points of intersection.

$$1 \times 0 = 0 \quad 0 \times 1 = 0$$

2. Peter gives Susan 5 pens 0 times or 0 pens 5 times

Task: Children attempt pages 57 to 60

Additional resources:

At the end of the guide are additional worksheets 10 and 11. Use them for reinforcement

Fractions

- i. Recognise fractions as equal parts of a whole
- ii. Identify half, one third and quarter with the help of objects and figures (without writing $\frac{1}{2}$, $\frac{1}{3}$, $\frac{1}{4}$)
- iii. Represent half, one third and quarter in numerical form ($\frac{1}{2}$, $\frac{1}{3}$, and $\frac{1}{4}$)
- iv. Shade the equal parts of a given figure to match a given fraction
- v. Recognise and name unit fractions up to $\frac{1}{10}$
- vi. Recognise fractions like two thirds ($\frac{2}{3}$), three fourths ($\frac{3}{4}$), four fifths ($\frac{4}{5}$), up to nine tenths ($\frac{9}{10}$)

Lesson 1: Fractions

40 minutes

Children encounter parts of a whole from a very early age. A birthday cake is shared amongst 10 friends, a chocolate bar is shared by 2, an apple is sliced into 4 pieces, a pizza divided into 6 or 8 parts ... these are real life examples.

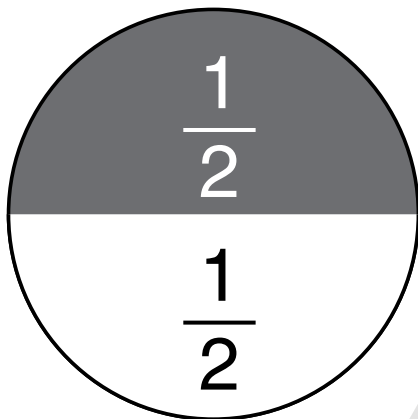

At the end of these activities, the children should be able to write fractions correctly with a horizontal bar, and will understand the significance of the numerator and the denominator in a fraction.

Use plasticine or play dough to make different shapes: square, circle, triangle, rectangle. Cut each one into two equal parts. Explain that each part is 1 of 2, or HALF of the whole. This should be quite easy to understand.

Give the children some worksheets with different shapes, such as squares, triangles, circles, and rectangles drawn on them, in rows. Ask them to draw on the dotted line given to show the halfway point.

They should shade only one half of each shape and write $\frac{1}{2}$ on each part. Refer to worksheet 9.

Task: Children attempt pages 62 and 63.

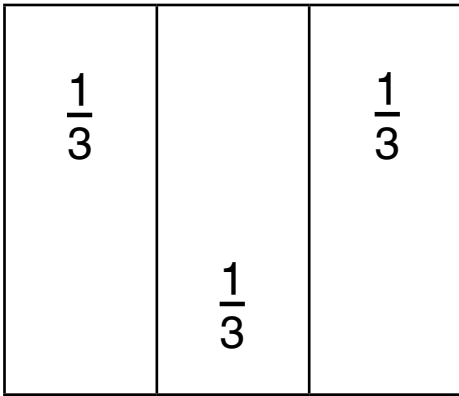
Lesson 2: Fractions (continued)**40 minutes**

The children should understand one-third as, one out of 3 equal parts. Ask them to draw on the dotted lines given to divide into 3 equal parts, on the second row of the shapes on the worksheet (similar to the ones used for $\frac{1}{2}$) that they have worked on, and colour one part, to show $\frac{1}{3}$.

Task: Children attempt pages 64 and 65.

Lesson 3: Fractions (continued)**40 minutes**

Ask, 'How much will each child have if the cake is shared equally amongst 4 children?'

The children will gradually understand the significance of the horizontal bar.

$\frac{1}{2}$ is one out of two equal parts, $\frac{1}{3}$ is one out of 3 equal parts; $\frac{1}{4}$ is one out of 4 equal parts and so on. Is there any other method of cutting the cake into $\frac{1}{4}$ s? Slice it horizontally.

What about a triangular cake?

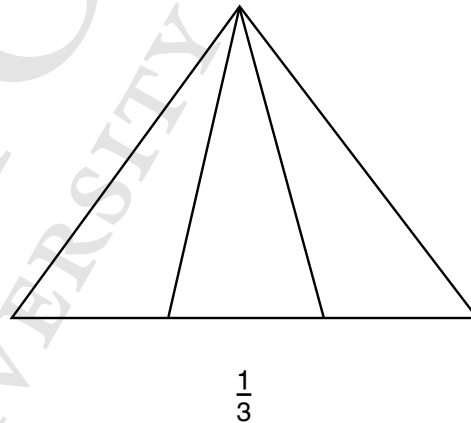
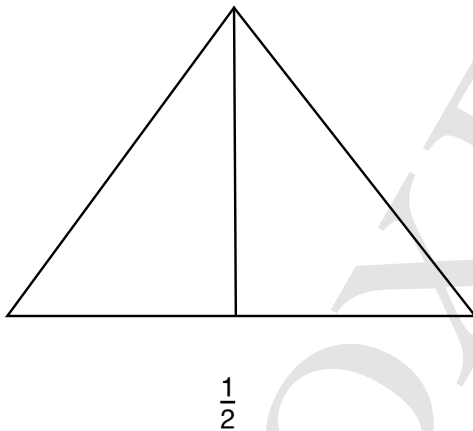

Task: Children attempt pages 66 to 68.

Lesson 4: Fractions (continued)**40 minutes**

The next step is to work with a whole group of objects.

A packet contains 12 marbles. Half the packet will contain 6 marbles.

Half of a box of 10 sweets is 5 sweets.

One third of a class of 15 children is 5.

Give each child a set of Lego cubes joined to form a block as shown below. Discuss the fractions $\frac{1}{2}$, $\frac{1}{4}$, $\frac{1}{8}$ and so on as shown in the diagram. Also show how parts of the whole can be joined together to make the whole again.

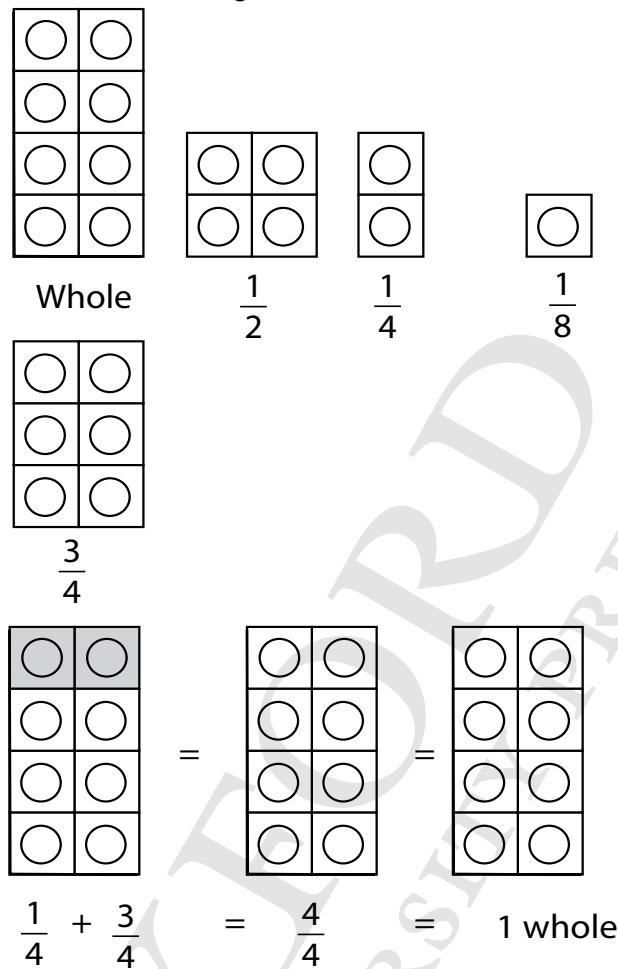

Apply fractions to every day life. Arrange a class picnic. On the menu there are cakes, pizzas, some apples, and a variety of fruit that can be cut into equal parts; also drinks such as water and juice.

Children see that a whole can be cut into equal parts called fractions. Ask questions such as:

1. How many parts have you broken the chocolate bar into?

(Ans: 10. There are 10 equal pieces. Each piece is $\frac{1}{10}$ of the whole)

2. How many parts has the pizza been cut into?

(Ans: 8. There are 8 equal pieces. Each piece is $\frac{1}{8}$ of the whole.)

3. How many slices of bread in a loaf?

(Ans: There are 12 slices. Each slice is $\frac{1}{12}$ of the whole loaf.)

Arrange a game of paper toss. Put a basket in the middle of the classroom. Let the children make 10 balls of paper, 5 red, 2 blue, and 3 yellow. Allow each child to take turns to toss the paper balls into the basket. 'What fraction of the balls landed in the basket? What fraction did not land in the basket? What fraction of the balls in the basket are yellow? Red?'

Task: Children attempt page 69 to 72.

Additional resources:

At the end of the guide are worksheets 8 and 9. Use them for reinforcement.

UNIT 5

MEASUREMENT: LENGTH, MASS, AND CAPACITY

Length

- i. Compare the lengths of different objects
- ii. Recognise the units of length (metre and centimetre)
- iii. Use standard metric units of length (metre and centimetre) and their abbreviation to measure and record lengths of variety of objects
- iv. Use addition and subtraction within 100 to solve real life situations involving lengths in same units

Mass

- i. Compare the mass of different objects
- ii. Recognise the units of mass, i.e. kilogram, gram
- iii. Use standard metric units of mass (kilograms and grams) and their abbreviation to measure and record mass of variety of objects
- iv. Use addition and subtraction within 100 to solve real life situations involving mass in same units

Capacity

- i. Compare capacity of different objects using nonstandard units (jug, glass, cup, etc.)
- ii. Recognise and use the standard metric units of capacity, i.e. litre and millilitre
- iii. Use addition and subtraction within 100 to solve real life situations involving capacity in same units

Teaching materials:

- metre ruler and tape measure
- ribbons or streamers
- measuring wheel

Learning activity

Lesson 1: Length

40 minutes

Start the lesson with a story about ancient times, when man used various standards to measure length, for example the span of hand, footsteps, and cubits (a cubit is roughly equal to the length of the forearm). Make the plot of the story such that, at the climax, two men end up having a fight because both men used a cubit to measure a certain length, but one man used a longer cubit than the other.

Let the children brainstorm the different ways in which the problem could have been resolved. Using a standard measurement would be an obvious solution. Tell them that a marked portion of the length of a platinum iridium bar, kept at a standard temperature, represents 1 metre and is used all over the world as a standard measure of length.

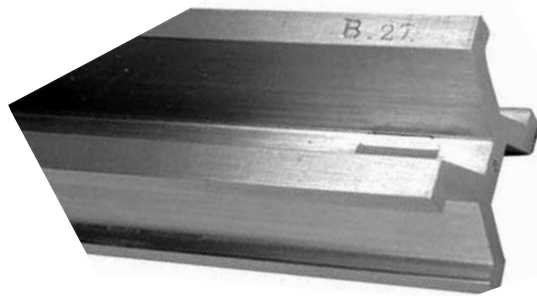

Platinum iridium bar

Show them a picture of the bar. Show the children a metre ruler (1 m). Let them compare the lengths of various objects they see around them (window panes, doorways, his or her own height, the height of a table, etc.) with the metre ruler.

Remember:

- a room, a tripod stand for a camera, or a building has height
- a road, a dupatta, the screen of a laptop, or a cellphone has length and width (or breadth)
- a table has height, and its tabletop has length and breadth (or width)
- a sheet of chart paper or the floor of a room has length and breadth (or width)

Encourage them to examine a metre ruler thoroughly, and see that it is divided into 100 equal divisions; explain that each small division is called a centimetre. Let them compare objects of shorter lengths, using centimetres as units of measurement.

Display an assortment of rulers and tapes. Children need to handle the instruments and feel comfortable with the numbers and the divisions on the scales. Once they are ready, they can use the edges of rulers to draw lines of different lengths.

Task: Children attempt pages 74 to 77.

Lesson 2: Length (continued)

40 minutes

Take the children out for an excursion to a fabric shop and show them how the shopkeeper uses a metre ruler to measure lengths of fabric. If time permits, take them to a doctor's surgery, a tailor's shop, and a shoe shop, to show them how the lengths of the different parts of the body are measured by a tailor, the height is measured by the doctor, and the length of the feet by the shoe shop assistant (sizes 3, 4, 5, and so on).

It is important to point out that a metre rod is used horizontally to measure length, e.g. of fabrics, ribbons, or a tabletop, and vertically to measure height, e.g. of people or doors.

Take the children out into the playground and play Statues. Call out instructions such as, 'Statue with your hands 10 cm apart', 'Legs 50 cm apart', and so on. As the children stand displaying their estimated lengths, use a measuring tape to check their accuracy.

Divide the children into groups. Give each group a distance measuring wheel, with a circumference of 1 m, measure the circumference with a tape, and let the class see. Mark a point on the circumference. They can roll it around the

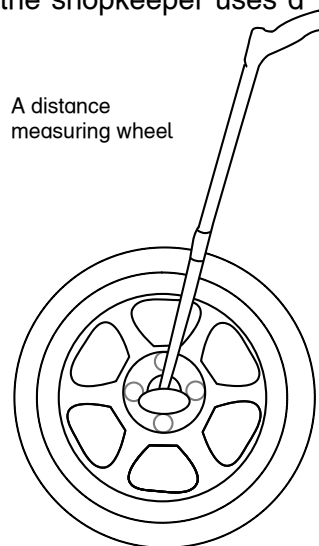

playground and measure the lengths of various areas.

The children can decorate the classroom with ribbons and streamers; they should estimate the lengths of the ribbons or streamers required, and cut them to size accordingly.

Task: Children attempt pages 78 and 79.

Lesson 3: Mass

40 minutes

An introduction to mass is similar to that of length. The unit for measurement of weight is the gram (g), but it is the kilogram (kg) that is more commonly used because the gram is too small a unit for use in daily mass measurements (such as meat, vegetables, and fruit for the kitchen, or cement for building a wall) and needs very specialized scales. Valuable metals, chemicals, and impurities in water are measured in grams. A visit to a local shop or a market can be useful. The children can see for themselves the different measuring scales and form an idea of quantities.

It is important that they learn to compare the masses of two different objects such as a cotton wool ball and a golf ball, by first holding one in each hand, and then putting one on each pan of a balance.

Task: Children attempt pages 80 and 81.

Lesson 4: Mass (continued)

40 minutes

It can be fun to use a common balance or scales in the classroom. Let the children work in groups.

Give them various pairs of objects, such as a pen in a box, a packet of biscuits, a packet of marbles, and a mobile phone. Ask them to guess which of the two is heavier (as was done in the last lesson). The side of the balance containing the heavier object will go down, and the one containing the lighter object will rise. Ask them to arrange a few objects according to their relative masses..... ascending order and descending order.

Then, various objects can be weighed on a metric balance that display masses instantly. Each child can see his or her own masses on weighing scales too.

Bring 10 kg, 1 kg, 500 g, 100 g, and smaller weights to class. Let the children feel the weights in the palms of their hands. Now ask them to compare the weights of some classroom objects to the standard measures. They may use the balance to check whether their estimates are correct. Discuss the suitability of various weights to measure different objects.

Which units are suitable to measure the mass of:

- a cabbage (500 g and 100 g)?
- a bag of flour or rice (1 kg, 5 kg or 10 kg)?
- a whole fish or a slice of fish (1 kg and a few 100 g)?
- How many packets of biscuits will weigh as much as a tin to hold the biscuits?

Justify their choices by practically measuring the various food items.

Task: Children attempt pages 80 to 83.

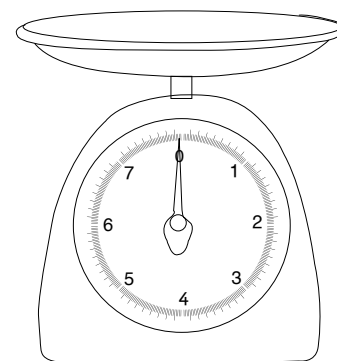

Lesson 5: Measurement of capacity

40 minutes

The capacity of a container refers to the amount it can hold. The unit for measuring capacity is the litre: for example, a bottle can hold 1 litre of water. The same bottle can also hold 1 l of juice, 1 l of milk or 1 l of tomato sauce, though the various liquids may have different weights

The capacity of the container has nothing to do with its weight. The weight of 1 l of water is 1 kg.

Compare the masses of:

- 1 l of sauce
- 1 l of tomato juice
- 1 l of oil

(Why does oil from spills float on water? Oil is lighter than water and oil and water do not mix.

Why does a slab of wood float on water? Why does a metal spoon sink in water?)

Show them containers that can hold $\frac{1}{2}$ a litre, $\frac{1}{4}$ litre, or 5 litres of water. These containers will hold the same amount of juice, or oil, or milk (measured in litres). The weight of each will be different. Let them form an idea about the quantity each of these measures represents.



A visit to the petrol pump or a CNG station is quite awe-inspiring. (A great deal of supervision is necessary to make sure that the children do not touch anything there.) Children watch the fast-changing numbers on the screen; they realize that these moving numbers show the number of litres of petrol going into the car.

Guessing the capacity of various containers also makes an interesting activity... a watering can, a mug, an empty hand lotion bottle, an empty jam jar, a frying pan (difficult!) or a clay pot.

Introduction to millilitres begins here, but the unit is too small for the children to actually guess capacities in millilitres.

It is important, however, to show various capacities so that children realize that

1000 ml = 1 litre, and 500 ml = $\frac{1}{2}$ litre.



Task: Children attempt pages 84 to 86.

Additional resources:

At the end of the guide are additional worksheets 12 and 13. Use them for reinforcement.

OXFORD
UNIVERSITY PRESS

Time

- i. Recognise the number of hours in a day and numbers of minutes in an hour
- ii. Read and write the time from a clock in hours and minutes (with five-minute intervals) e.g. read 8:15 as eight fifteen and 8:50 as eight fifty
- iii. Recognise a.m. and p.m.
- iv. Draw hands of a clock to show time in hours and minutes (with five minutes intervals)
- v. Use solar calendar to find a particular date/day
- vi. Use Islamic calendar to find a particular date/day

Teaching materials:

- clock with movable hands
- a 12-hour clock and a 24-hour clock
- different types of digital clocks
- lunar and solar calendars

Learning Activity**Lesson 1: Time****40 minutes**

In the previous year the children were introduced to months, weeks, days, hours, minutes, and seconds. They also learned how to tell the time, having played with toy clocks with movable hands and seeing time displayed on wristwatches, computers, and mobile phones. Their understanding of time comes from the fact that all their activities are time related.

For example: Today is Monday, 16 March, 2014; a new year begins on 1st January every year; Christmas falls on the 25th December every year; my birthday is on 12th July; summer holidays start on 15th May; games lesson is every Wednesday in the 3rd period which begins at 11.15 a.m.; breakfast is at 7 am; school starts at 9 a.m.; dinner time is 7 pm; bedtime is 9 p.m., and so on. Refer to events like 'Lunch is at a quarter to 2 in the afternoon,' as 1.45 pm, and 'the first lesson begins at half-past nine' as 9.30 or 9.30 a.m.

Use a real clock (24 hour clock if possible) to show the 12 hours before noon (ante meridian – a.m.) and the 12 hours after noon (post meridian – p.m.) with explanations for half past, a quarter past, and a quarter to. They memorize the positions of the hands of the clock at these times. Now ask them to stand in a circle and to use their arms like the hands of a clock. As you call out different times, they show the time by rotating their arms and holding them in the required positions.

Task: Children attempt pages 88 and 91.

Lesson 2: Time (continued)**40 minutes**

On a digital clock ask children to look for times when 2 numbers are repeated. For example: 03:30; 05:50; 12:12; 12:21; 13:13; 13:31; 15:15; 15:51; 21:21 21:12.

Find other patterns in time:

11:11; 22:22

01:23; 12:34; 23:45

11:22; 11:33; 11:44; 11:55

22:11; 22:33; 22:44; 22:55

(Time cannot be 33:33 OR 09:90 OR 17:71. Why not?)

Task: Children attempt pages 92 to 94.

Lesson 3: Time (continued)**40 minutes**

Ask the children questions such as:

- Where are you at midnight?
- What do you do at 8 a.m.?
- What do you do at 11 a.m.?

Each child lists some of his or her activities, time-wise, beginning in the morning.

Explain the use of a.m. and p.m. Give the children plenty of practice before attempting the exercises.

Task: Children attempt pages 95 and 96.

Lesson 4: Date**40 minutes**

Give each child 12 square sheets of paper, and help them to prepare a calendar for the year. They prepare 1 page for each of the 12 months of a year, with the help of a wall calendar. Each child adds a suitable picture for each month. Display the calendars and ask why they chose a particular picture for that month.

Talk about the number of days in the 12 months:

How many months in a year have 30 days each?

How many months in a year have 31 days each?

There is one month which has less than 30 days? (Discuss 28 and 29 days in February, and leap years.)

Ask the children to mark in red on the calendar the following: Eid, Muharram, Christmas, May Day, Independence Day, and other national and international holidays.

The knuckles of both fists placed together help in memorizing the number of days in each month.

Hold both the fist together in front of you. Start with January on the left little knuckle of your left hand. Other months have 30 days, except February, which has 28 or 29 days.

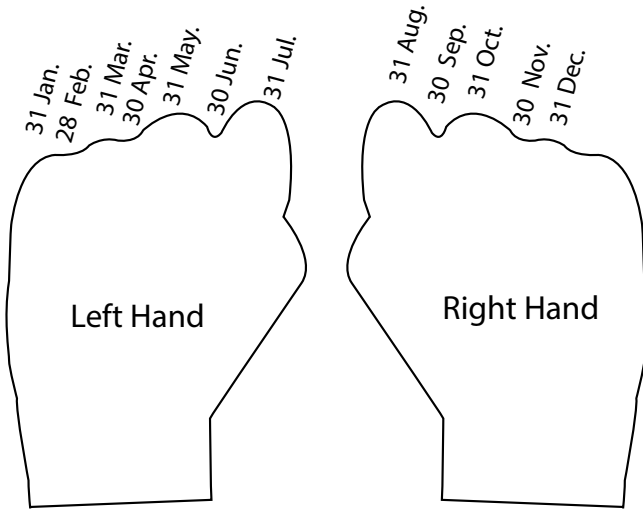

An old rhyme to remember the number of days in each of the months of the year:

30 days have September,
 April, June, and November:
 All the rest have 31,
 Except February,
 Which has 28 days clear,
 And 29 in each leap year.

Draw a number line on the board, with numbers from 1 to 12 written (as shown below) for each month of the year.

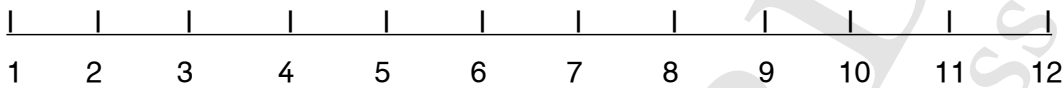

The initial letters of the 12 months are:

A, A, D, F, J, J, J, M, M, N, O, S

Children write these letters on the number line in order:

January, February, March up to December.

Ask the children to write the following:

- his or her birthday
- siblings' birthdays
- parents' birthdays
- best friend's birthday
- teacher's birthday

Ask the children to find number patterns in the dates of the calendar. For example: is there a pattern in the dates for all Fridays or Tuesdays in a month? Does each day, for example Saturday, appear 4 times in a month? Which are the months when some days appear 5 times?

Here are some interesting points about the year 2014:

The pattern of the year 2014 is identical to that of 1947, the year Pakistan was born.

EACH OF THESE DATES FELL ON A FRIDAY:

- 04.04.2014 (4 April was a Friday)
- 06.06.2014 (6 June was a Friday)
- 08.08.2014 (8 August was a Friday)
- 10.10.2014 (10 October was a Friday)
- 12.12.2014 (12 December was a Friday)

EACH OF THESE DATES FELL ON A SUNDAY:

01.01.2014(1 January was a Sunday)

02.02.2014 (2 February was a Sunday)

03.03.2014 (3 March was a Sunday)

Ask the children to complete the list

Task: Children attempt pages 97 to 100.

Lesson 5: Date (continued)

40 minutes

A reference to the lunar calendar is necessary, as Eid and Muharram do not fall on the same day every year. The lunar calendar follows the phases of the Moon. Dates and times of the start of each month are available on the net.

Explain that in the lunar calendar the months are measured according to the phases of the moon. Name the important months and religious festivals that Muslims celebrate according to the lunar calendar.

Explain that Islamic years are counted from the event of the Hijra of the Prophet Muhammad (PBUH). Ask the children to repeat the names of the Islamic months after you. They should then memorize the names of the months.

- | | |
|----------------------|----------------------|
| 1. Muharram | 7. Rajab-ul-Murjjab |
| 2. Safar-ul-Muzaffar | 8. Shaban-ul-Moazzam |
| 3. Rabi-ul-Awwal | 9. Ramzan |
| 4. Rabi-us-Sani | 10. Shawwal |
| 5. Jumad-al-Awwal | 11. Zulqaadah |
| 6. Jumad-as-Sani | 12. Zil-Hajj |

Task: The children memorize the names of the months in the Islamic calendar.

Children attempt pages 101 and 102.

Additional resources:

At the end of the guide is an additional worksheet 14. Use it for reinforcement.

Two dimensional figures

- i. Identify the figures like square, rectangle, triangle, circle, semi circle, and quarter circle
- ii. Identify vertices and sides of a triangle, rectangle and square

Straight lines and curves

- i. Differentiate between a straight line and a curve
- ii. Identify straight lines and curves from the given drawings
- iii. Use ruler to draw a straight line of given length (exclude fractional length)

Patterns

- i. Make/complete geometrical patterns on square grid according to one or two of the following attributes
 - Shape
 - Size
 - Orientation

Three dimensional (3D) objects

- i. Recognise and name 3D Objects (cubes, cuboids, cylinder, cone, sphere)

Teaching materials:

- wooden or plastic letters and numerals
- rectangular sheets of coloured paper
- cut outs of various shapes
- a few lengths of rope
- a ruler
- Wooden 3D shapes and objects from daily life

Learning activity**Lesson 1: 2D figures****40 minutes**

Children have seen many geometrical shapes (2D and 3D) since they were born. 2D shapes include the shapes of the ceiling, walls and windows, the rectangular rim of a cot, a table or picture frames, spheres (balls), sugar cubes, various cuboid boxes, the circle and the oval of the mother's eye, and the triangles of clothes' hangers. 3D objects include a milk bottle, the hand of the mother, dolls, the duck in the bath tub, a ball, and so many other objects. Children may not know the geometrical names, but they are indeed familiar with these shapes.

The concept of geometrical shapes and their properties is best introduced and explained with hands-on activities in the classroom. Show plastic or wooden letters of the alphabet and numerals from 0 to 9.

These make excellent tools for introducing basic geometric concepts such as straight and curved lines, and closed and open shapes.

Talk about the letters of the alphabet and numerals written using only straight lines or only curved lines, or both straight and curved lines. They should write these in their exercise books, in a large, bold writing.

Then, they trace the letters and numerals with a pencil, starting from a point. If the pencil returns to the starting point without having to lift it, the letter is a closed shape. For example: letters such as O, and parts of A, B, D, and Q and numerals such as 8 and 0. Ask them to identify closed and open shapes in objects they see in the classroom or in real life. A clothes' hanger has a closed triangular shape and an open shaped hook. The rim of a glass or a bowl is a closed figure.

Then, with your help, each child folds a piece of papers to make a square, a triangle, a rectangle, and other familiar shapes.

The children enjoy making simple origami figures. Call out the names of the shapes as you make the folds, as you create the figure. They follow the steps and make simple origami shapes. (Very interesting books are available which show simple shapes.)

Task: Children attempt page 104.

Lesson 2: 2D figures (continued)

40 minutes

Use cutouts of various triangles, squares, and rectangles. Let the children count and list the number of sides and corners (vertices).

<u>Shape</u>	<u>No. of sides</u>	<u>No. of vertices</u>
Square	4	4
Rectangle	4	4
Triangle	3	3

Ask them to find a pattern ... Are there ALWAYS as many sides as vertices?

Talk about a circle in this context: it is a single closed shape and has no vertices.

At this point, introduce the concepts of area and perimeter. To demonstrate the perimeter of a shape, ask the children to colour along the edges of any 2D shape. To demonstrate area, ask them to colour the surface of the shape. Explain or elicit that the edge of a windowpane is the perimeter and the glass pane is the surface.

Take the children into the playground for this activity. Ask them to work in groups of 5 and give each group a long piece of rope. Call out a shape, for example, a square. The children should make the shape using the rope as the sides and themselves as the vertices. For example: for a square, 4 children hold the rope, and stretch it to make equal sides. The children standing at the 4 corners are the vertices and the lengths of the rope are the sides. A little guidance will be necessary to make right angles for a square. Otherwise, the shape will become a rhombus: a quadrilateral with equal sides.

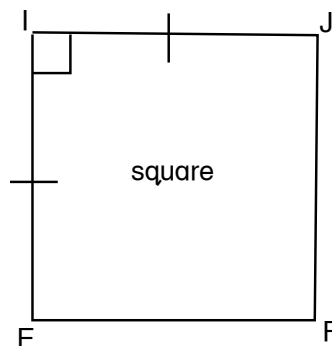
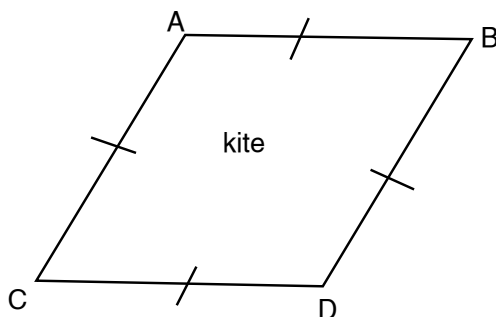

Task: Children attempt pages 105 to 108.

Lesson 3: Lines and curves

40 minutes

Ask the children to stand in one corner of the playground and ask one of them to bring an object from the opposite end. Ask the children to observe the route he takes. Note that he does not go along the wall. Instead, he walks along the diagonal, which is the shortest route. Talk about the shortest route. Even a bird will fly from one tree to the other, across the garden, along the diagonal of the garden! Why? The diagonal is a shorter route than going along the sides. Measurement will prove this.

Draw lines of different lengths on the board using a long ruler. Talk about the uses of a ruler and how it is used to draw lines. By observing you, the children will learn to draw lines of specific lengths in their books.

Then, they draw lines of specified lengths, and measure lines drawn by other children to check for accuracy.

You could also give them a drawing assignment in which you specify the lengths of the line segments to be drawn.

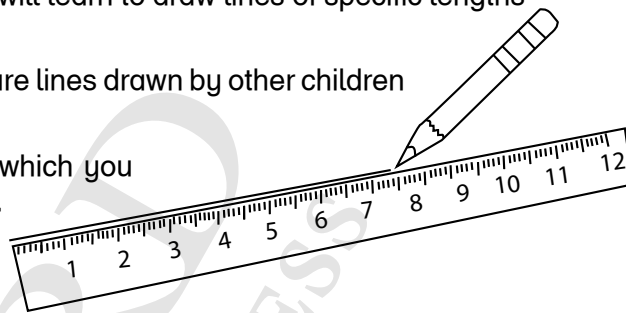

Task: Children attempt pages 109 to 112.

Lesson 4: Show them some real-life pictures presenting geometrical patterns.

For example, a piece of rug with repeated geometrical design on it or tiles with geometrical patterns on them.

Display cut-out of shapes arranged in repeated order.

Give them blocks of different colours to arrange in a sequence of different colour combinations.

Task: Students will attempt pages 113 and 114

Lesson 5: Tell students that they will learn about 3D geometrical shapes.

Show them 2D and 3D shapes, such as a triangle and a cone or a square and a cube.

Differentiate emphasising between 2D and 3D shapes showing objects from daily life.

Handover wooden 3D shapes of cube, cuboid, cone, cylinder, and sphere to them.

Ask them to feel the surface, edges, and corners of each shape by holding them.

Ask them to relate the wooden shapes with the objects around them. For example, their lunch boxes will match with cube or cuboid. Their water bottles may relate to a cylinder shape.

Task: Students will attempt page 115 and 116

Additional resources:

At the end of the guide are additional worksheets 15 and 16. Use them for reinforcement.

UNIT 8

REVIEW AND ASSESS 2

Teaching objectives

- to revise the concepts learnt throughout the year
- to recap place value
- to revise ascending and descending orders
- to revise fractions
- to solve problems using the four operations i.e. addition, subtraction, multiplication, and division
- to revise measurement and capacity
- to tell the time using a.m. and p.m.
- to recap horizontal, vertical, straight, and curved lines
- to identify geometrical patterns
- to recognise three-dimensional shapes

Teaching materials:

- additional worksheets

Learning activity

Lesson 1

40 minutes

Revise place values. Give the class plenty of practice both oral and written. It is important to recap before attempting to assess the children's learning, as this revises concepts taught earlier in the year.

Task: Children attempt page 119 and 120

Lesson 2

40 minutes

Revise fractions. As this is a difficult concept for the children to grasp, it will be helpful to refer to the unit on fractions to revise the topic.

Task: Children attempt pages 121 and 122.

Lesson 3

40 minutes

The most important concepts learnt in the early years are the four operations, i.e. addition, subtraction, multiplication, and division since they are the basis of all mathematics.

Give the children plenty of practice using the worksheets given. Refer to the explanations in the earlier units on addition, subtraction, multiplication, and division for further practice.

Task: Children attempt pages 123 to 126.

Lesson 4

40 minutes

Revise the work done on time and on horizontal, vertical, oblique, curved, and straight lines.

Task: Children attempt page 128.

Additional resources:

At the end of the guide are additional worksheets 17 to 22 and 24. Use them for reinforcement.

OXFORD
UNIVERSITY PRESS



Worksheet 1

Fill in the missing numbers.

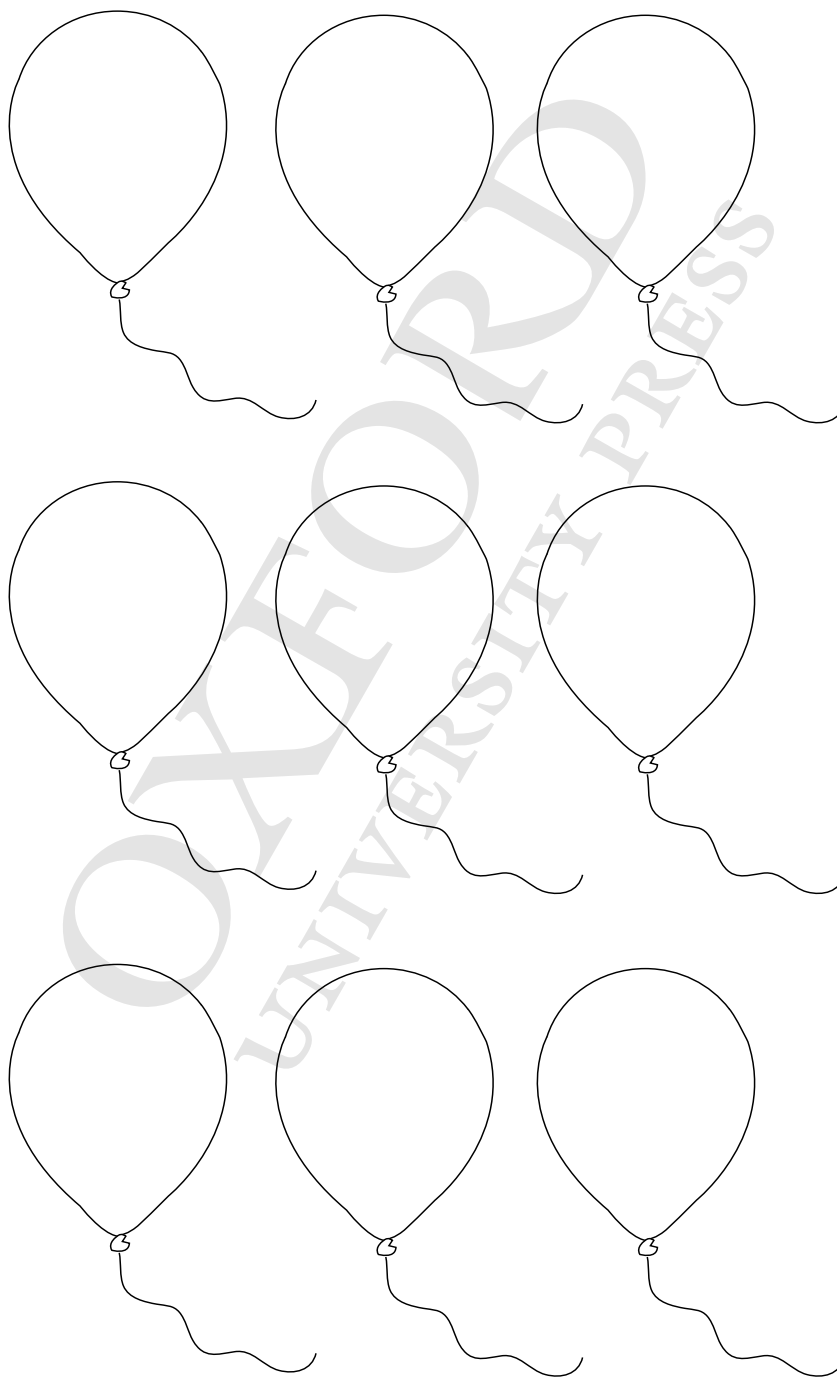



Worksheet 2

Count the shapes.

- Square _____
- Circle _____
- △ Triangle _____

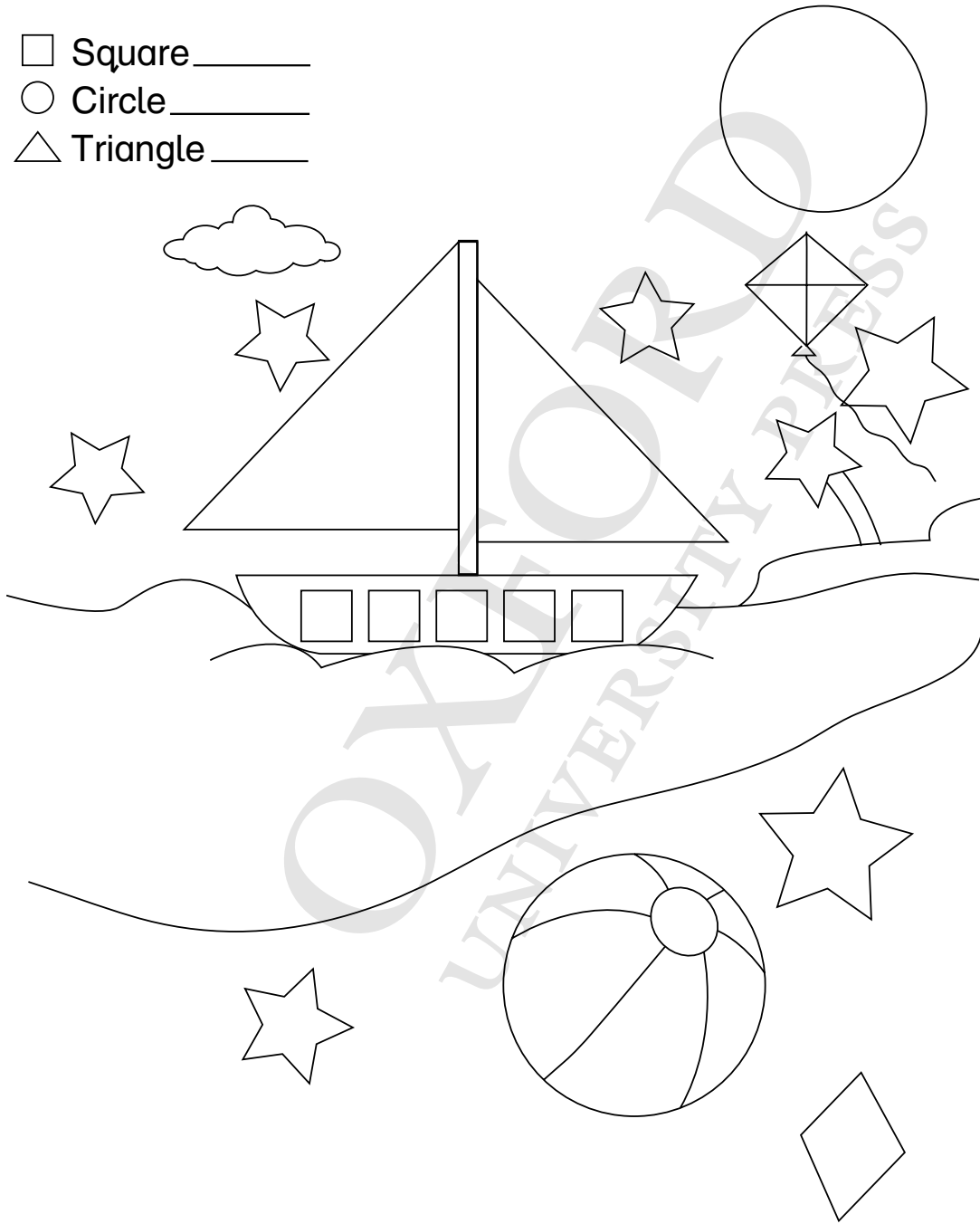



Worksheet 3

Trace and match.

EIGHT

ONE

THREE

FOUR

TEN

SIX

TWO

NINE

FIVE

SEVEN



Worksheet 4

Fill in the missing numbers.

1		3	
	6		8
9		11	
	14		16
17		19	
	22		24
25		27	

Worksheet 5

Fill in the missing numbers.

1. Count from 4 to 13.



2. Count from 12 to 21.



3. Count from 25 to 34.



4. Count from 15 to 24.



5. Count from 35 to 44.



6. Count from 41 to 50.



Worksheet 6

Place value.

Twenty five = 20 + 

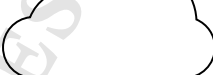
Thirty eight = 30 + 

Forty eight = 40 + 

Eighty six = 80 + 

Twenty nine = 20 + 

Fifty four = 50 + 

Worksheet 7

Write >, <, or = in the circles.

$5 \bigcirc 8$

$3 \bigcirc 2$

$9 \bigcirc 7$

$9 \bigcirc 8$

$1 \bigcirc 3$

$8 \bigcirc 4$

$9 \bigcirc 3$

$5 \bigcirc 6$

$8 \bigcirc 7$

$9 \bigcirc 4$

$6 \bigcirc 6$

$7 \bigcirc 5$

$5 \bigcirc 9$

$7 \bigcirc 3$

$9 \bigcirc 9$

$8 \bigcirc 6$

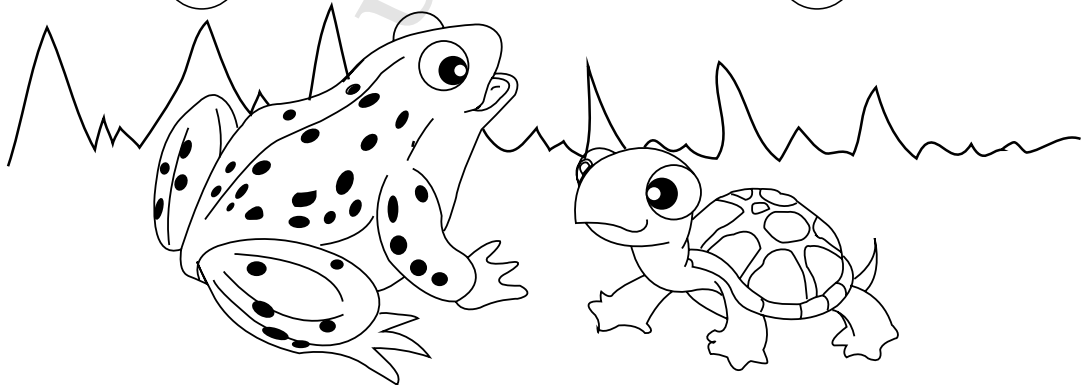

Worksheet 8

Colour the following figures according to the fraction written against each.

$\frac{8}{8}$

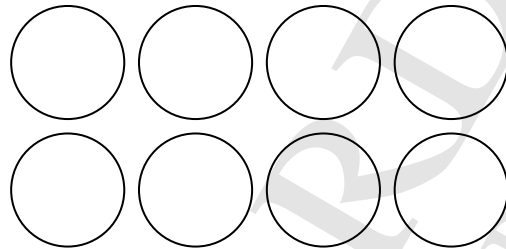

$\frac{10}{10}$



$\frac{3}{4}$



$\frac{7}{8}$

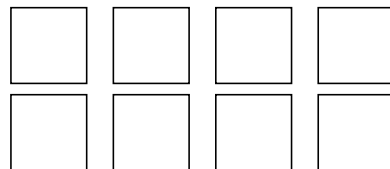



Worksheet 9

Trace and colour the given fraction.

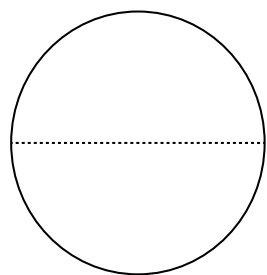

$$\frac{1}{2}$$

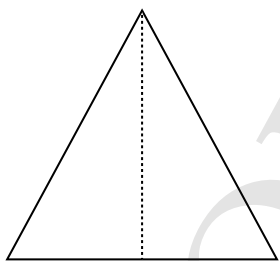

$$\frac{1}{2}$$

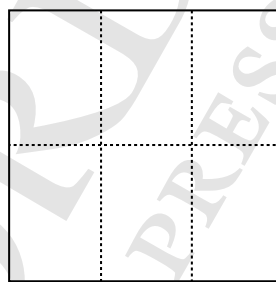

$$\frac{1}{2}$$

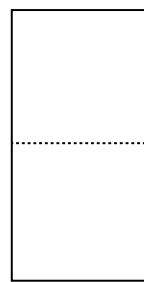

$$\frac{1}{2}$$

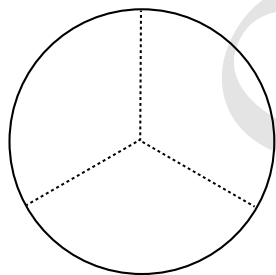

$$\frac{1}{3}$$

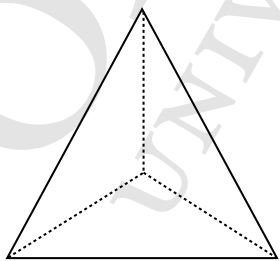

$$\frac{1}{3}$$

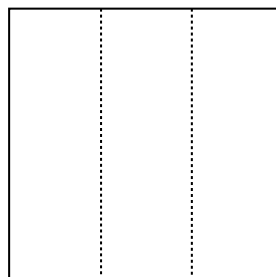

$$\frac{1}{3}$$

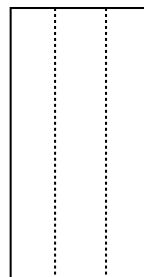

$$\frac{1}{3}$$

Worksheet 10

Count and write the correct number.

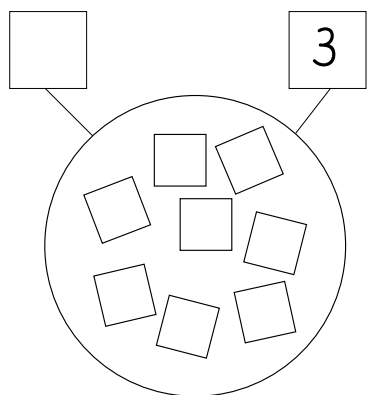

$$\underline{\quad} + 3 = 8$$

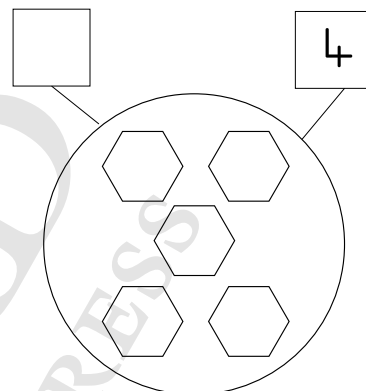

$$\underline{\quad} + 4 = 5$$

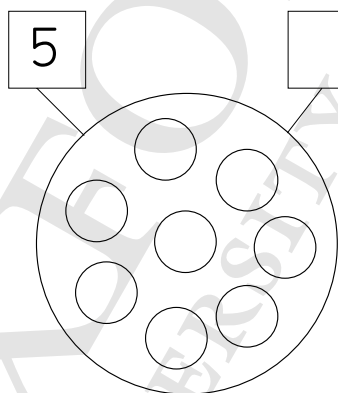

$$5 + \underline{\quad} = 8$$

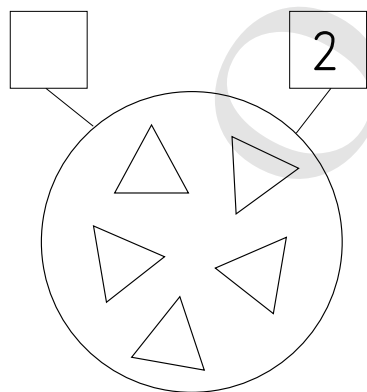

$$\underline{\quad} + 2 = 5$$

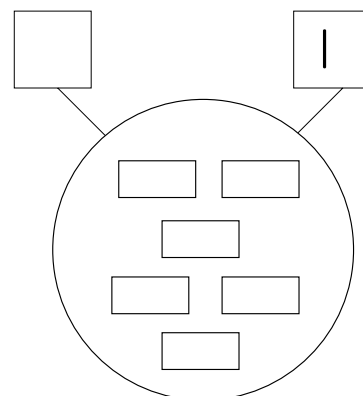

$$5 + 1 = \underline{\quad}$$

Worksheet 11

Write the answers in the given space.

$$6 \div 2 = \underline{\quad}$$

$$2 \times \underline{\quad} = 12$$

$$20 \div 5 = \underline{\quad}$$

$$5 \times \underline{\quad} = 20$$

$$30 \div 5 = \underline{\quad}$$

$$5 \times \underline{\quad} = 30$$

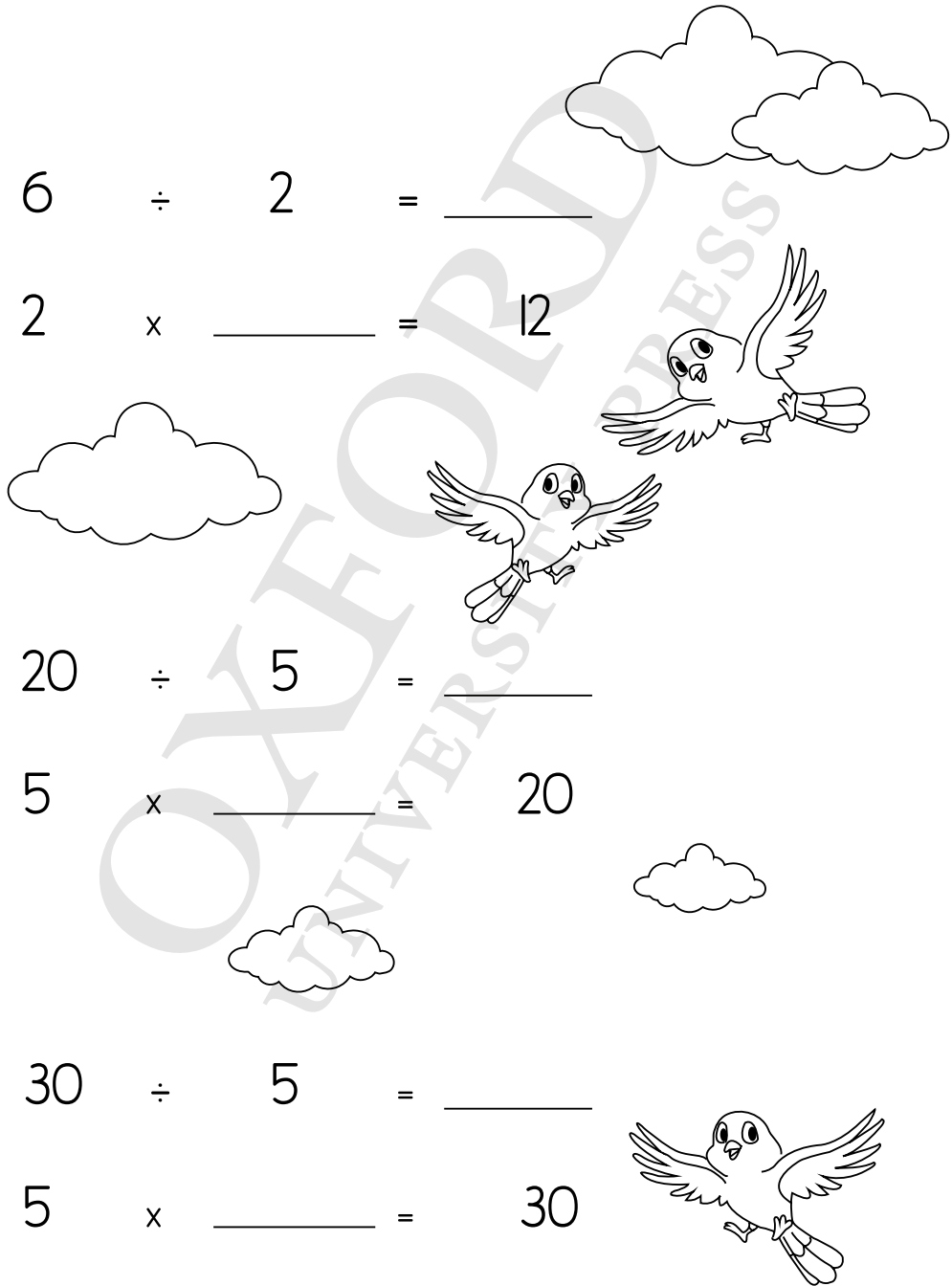

Worksheet 12

Will you use 'm' or 'cm' to measure:

Length of a door _____

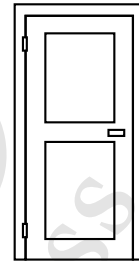

Length of a pencil _____

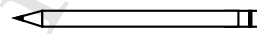

Length of a car _____

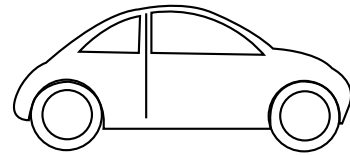

Height of a flamingo _____

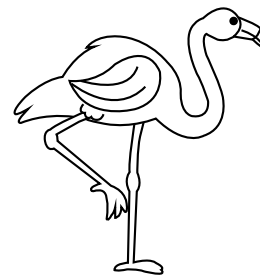

Length of a whale _____

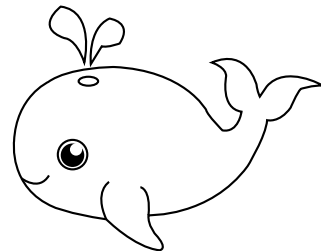



Worksheet 13

In each pair tick (✓) the object with the greater capacity.

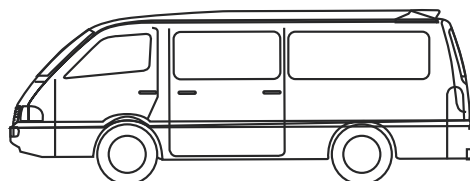
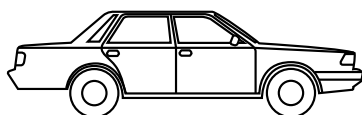
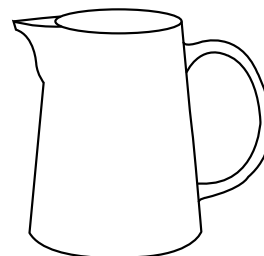
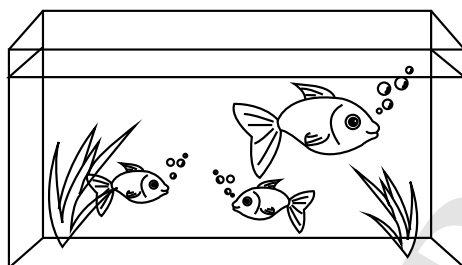

Worksheet 14

Draw hands on each clock to show the given time.

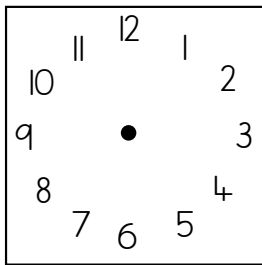

Half past 4

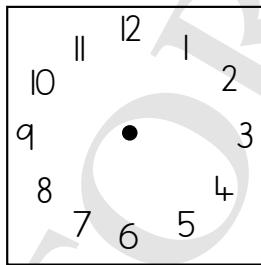

2 o'clock

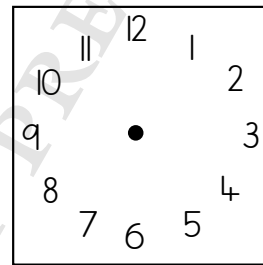

quarter to 9

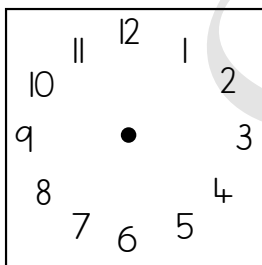

quarter to 6

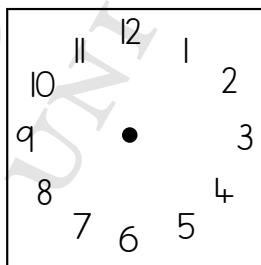

quarter past 3

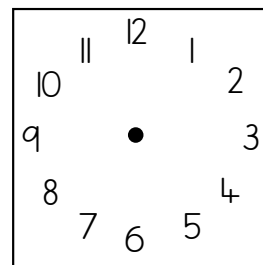

half past 7



Worksheet 15

Match the shape to its name.

diamond

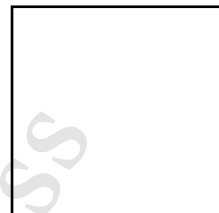

triangle

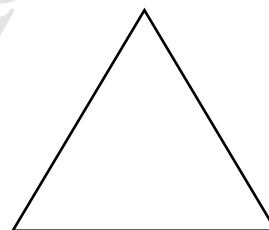

circle

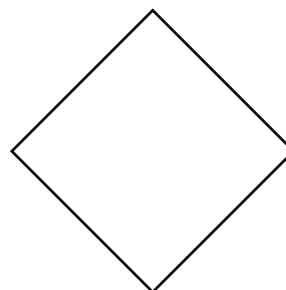

square

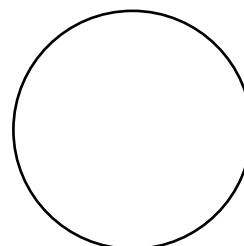

OXFORD
UNIVERSITY PRESS



Worksheet 16

In each group circle the objects you would use to draw the shape on the left.

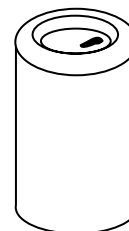
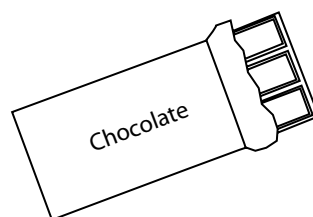
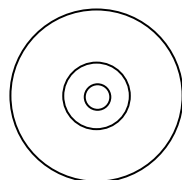
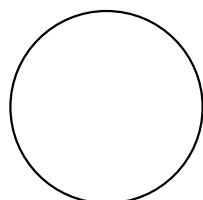
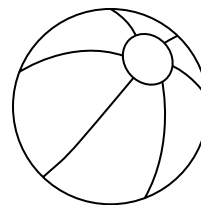
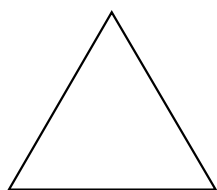
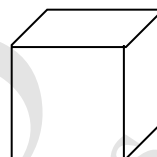
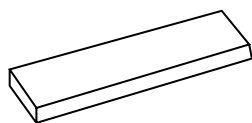
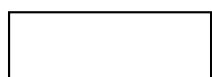

Worksheet 17

Draw the missing figure in each pattern.

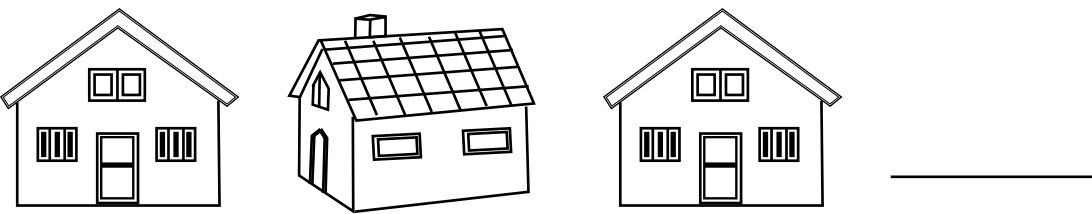
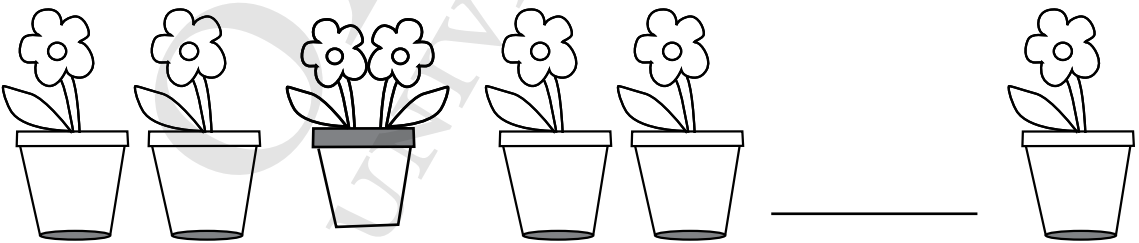
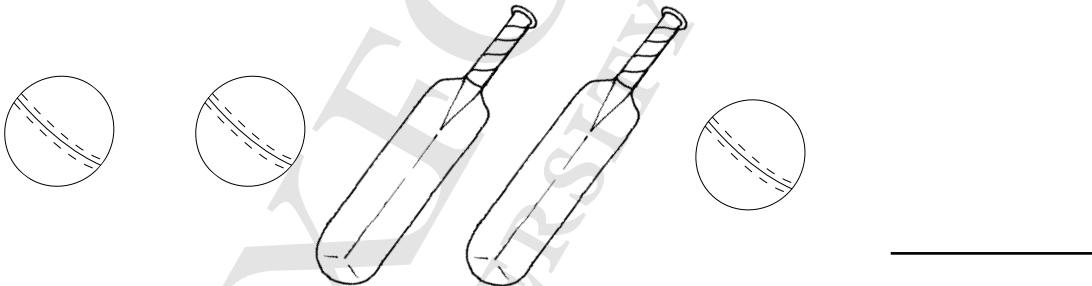
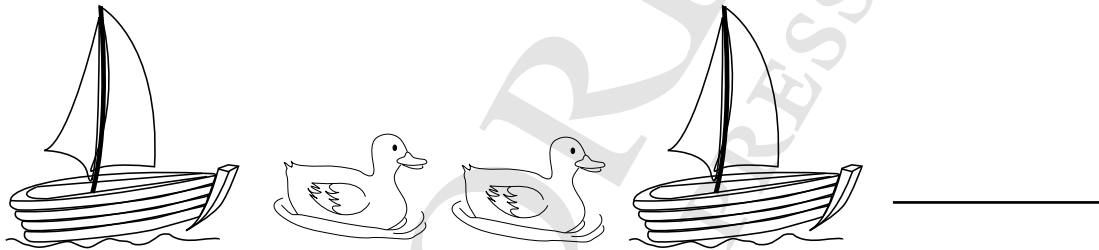
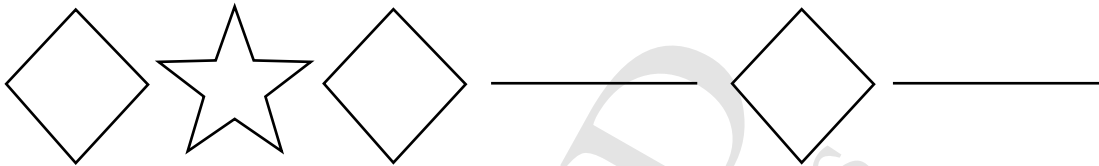



Worksheet 18

Circle the 3D Shapes.

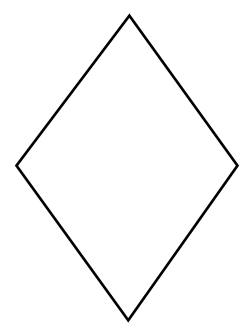
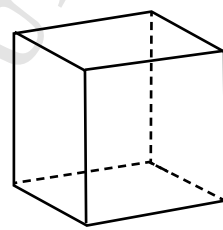
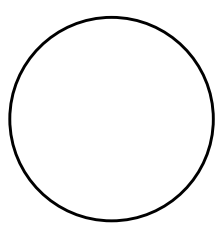
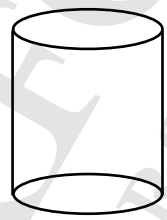
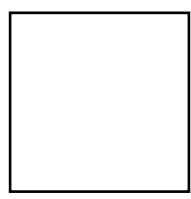
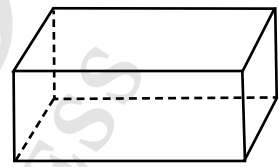
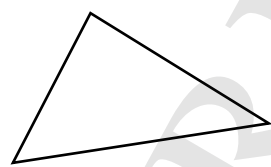
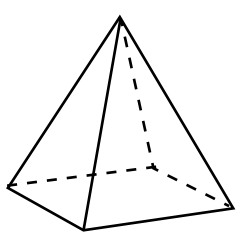

Worksheet 19

Write > or < in the circle.

$6 \bigcirc 11$

$4 \bigcirc 5$

$8 \bigcirc 3$

$9 \bigcirc 8$

$1 \bigcirc 4$

$6 \bigcirc 0$

$9 \bigcirc 23$

$10 \bigcirc 11$

$3 \bigcirc 7$

$9 \bigcirc 6$

$0 \bigcirc 6$

$10 \bigcirc 5$

$5 \bigcirc 8$

$4 \bigcirc 3$

$3 \bigcirc 5$

$9 \bigcirc 11$

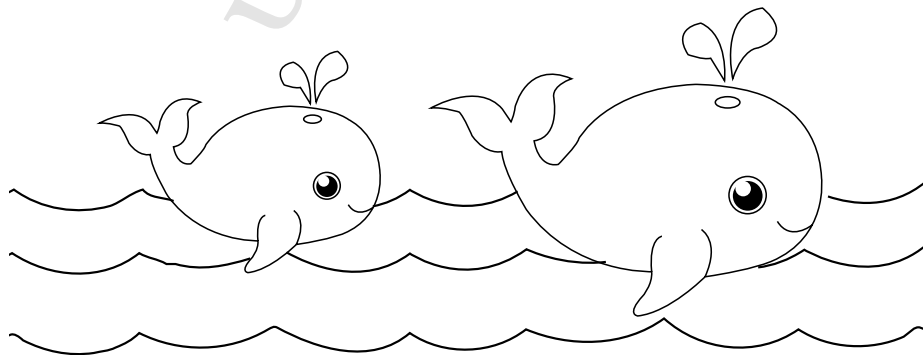



Worksheet 20

Trace the shapes and write their names.

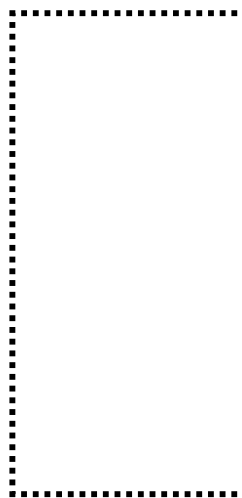
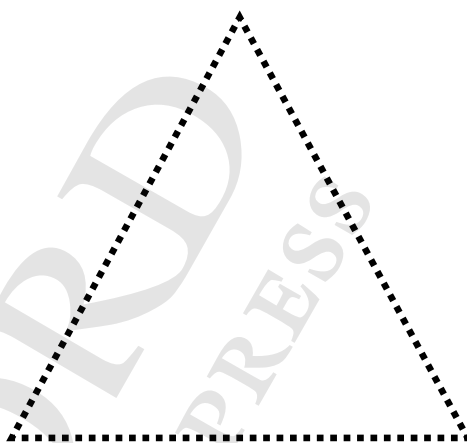
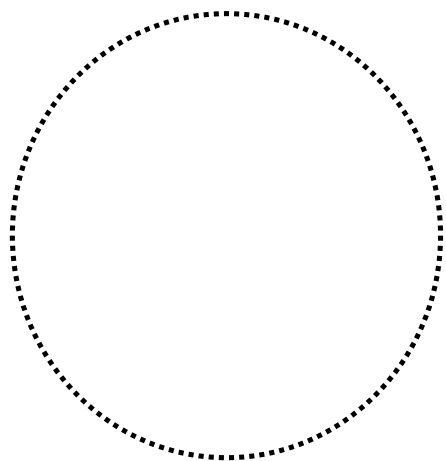



Worksheet 21

Write $<$, $>$, or $=$ in the circles.

$11 \bigcirc 4$

$4 \bigcirc 6$

$3 \bigcirc 9$

$8 \bigcirc 8$

$4 \bigcirc 6$

$0 \bigcirc 1$

$23 \bigcirc 10$

$11 \bigcirc 9$

$7 \bigcirc 9$

$6 \bigcirc 3$

$6 \bigcirc 10$

$5 \bigcirc 0$

$8 \bigcirc 4$

$3 \bigcirc 5$

$5 \bigcirc 9$

$11 \bigcirc 3$

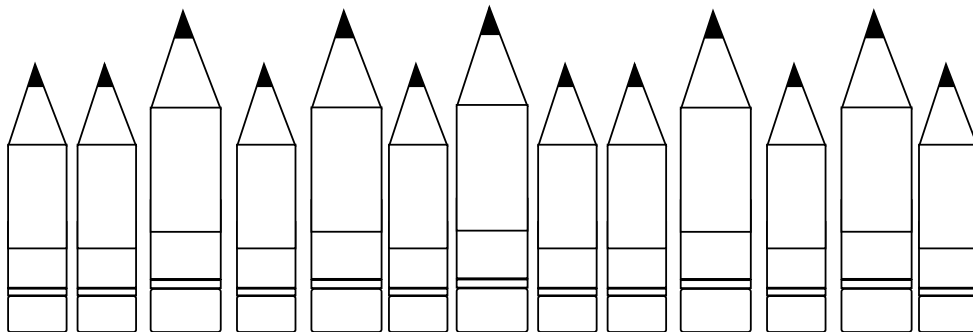

Worksheet 22

Ascending and descending order.

Write in ascending order.

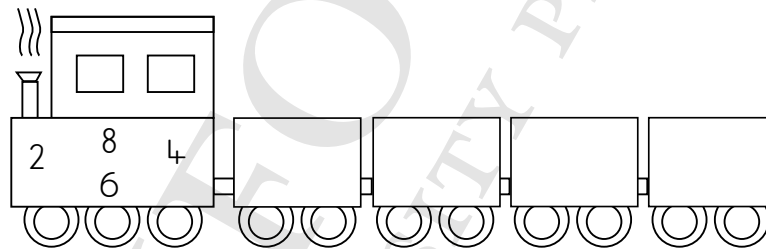
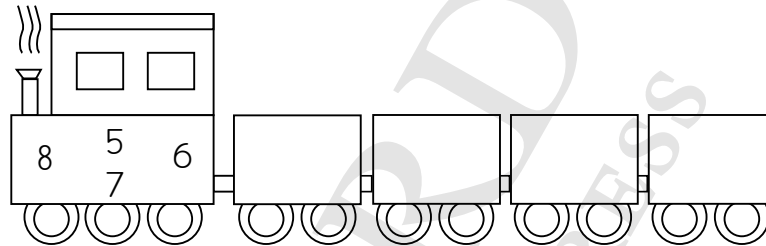

Write in descending order.

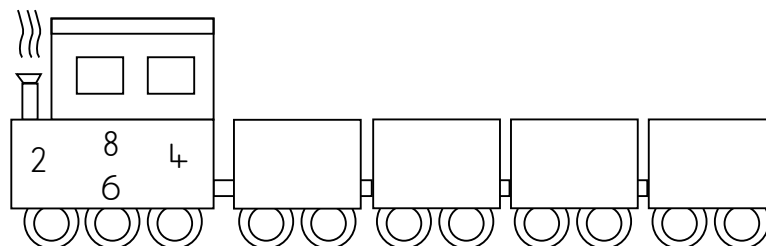
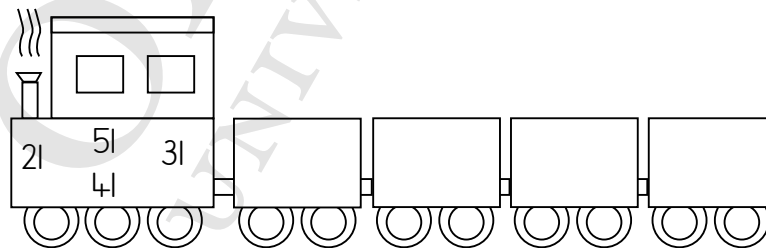

Worksheet 23

Colour the star with the given number name.

Nineteen



Eighty-eight



Seventy-eight



Seventy-six



Fifty-four



Twenty-four



Worksheet 24

Write the answers in the box.

$3 \times 4 = \square$

$6 \div 2 = \square$

$9 \times 6 = \square$

$9 \div 3 = \square$

$10 \times 4 = \square$

$15 \div 5 = \square$

$4 \times 6 = \square$

$10 \div 5 = \square$

$9 \times 5 = \square$

$16 \div 4 = \square$

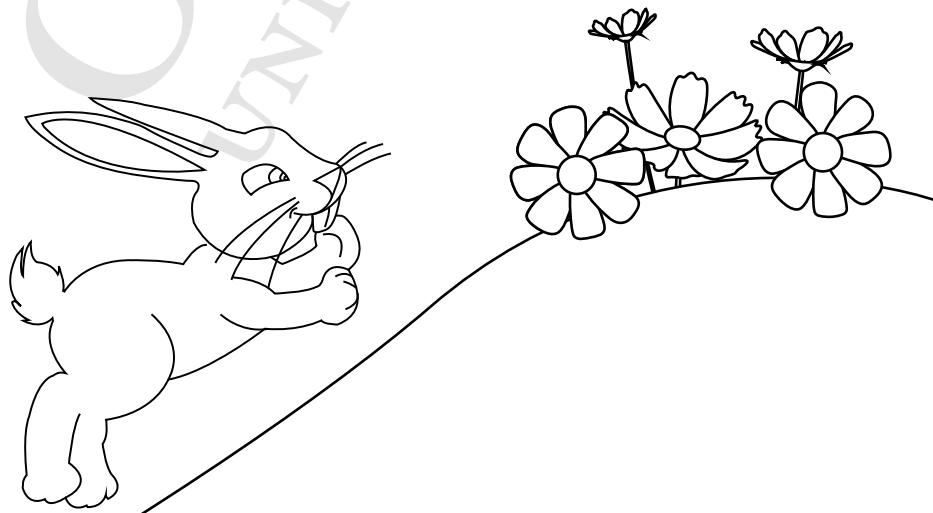

Answers to Unit 1

Page 2

Missing numbers: 3, 4, 5, 8, 9, 10, 12, 14, 15, 17, 18, 20

Page 3

Less, more, less, less, more, less, less

Page 4

9, nine; 8, eight; 7, seven; 6, six; 5, five; 4, four; 3, three; 2, two; 1, one

Page 5

Ladder 1: 17, 18, 19, 20, 21, 22, 23

Ladder 2: 91, 92, 93, 94, 95, 96, 97

Ladder 3: 28, 29, 30, 31, 32, 33, 34

Ladder 4: 44, 45, 46, 47, 48, 49, 50

Page 6

Snake 1: 77, 78, 79, 80, 83, 84, 85, 86, 87, 88, 89, 90, 91

Snake 2: 3, 4, 6, 7, 8, 10, 11, 12, 14, 15, 17, 18, 19

Snake 3: 89, 87, 86, 84, 83, 81, 80, 78, 77, 76,

Snake 4: 53, 52, 51, 50, 49, 47, 45, 44, 43, 42, 41, 39

Page 7

33, 67, 6, 11

Answers to Unit 2

Page 15

1st group of hens: 10

2nd group of hens: 10 and 8

Total number of hens on the page: 28

Page 17

Exercise 1

2. $600 + 90 + 2 = 692$

3. $8 \text{ hundreds} + 7 \text{ tens} + 5 \text{ ones} = 800 + 70 + 5 = 875$

4. $600 + 90 + 0 = 690$

5. $300 + 30 + 3 = 333$

Exercise 2

Numbers to circle: 2. 29 3. 876 4. 310, 20 5. 67, 960

Exercise 3

2. 898, 899, 900, 901, 902
3. 319, 320, 321, 322, 323
4. 457, 458, 459, 460, 461
5. 524, 525, 526, 527, 528

Exercise 4

2. seven hundred and sixty-five
3. nine hundred and nine
4. two hundred and sixty-five
5. eight hundred and ninety-seven

Exercise 5

2. 213 3. 768 4. 502
5. 979 6. 666

Exercise 6

2. 300 40 5
3. 700 60 4
4. 900 40 5

Exercise 7

2. 382 3. 741 4. 830

Exercise 8

2. 385 3. 863 4. 318

Exercise 9

2. 901 3. 317 4. 230 5. 657

Exercise 10

1. 390 2. 400 3. 580 4. 880

Exercise 11

2. 486, 476, 466, 456, 446
3. 668, 658, 648, 638, 628
4. 244, 234, 224, 214, 204

Exercise 12

2. 557, 657, 757
3. 265, 365, 465
4. 612, 712, 812

Exercise 13

2. TRUE
3. TRUE
4. TRUE
5. FALSE
6. FALSE

Exercise 14

1. less than
2. greater than
3. greater than
4. less than
5. less than
6. greater than

Exercise 15

2. Tick 788, cross 234
3. Tick 987, cross 124
4. Tick 907, cross 283

Exercise 16

2. descending
3. descending
4. descending
5. ascending

Exercise 17

1. 454, 456, 465, 654
2. 567, 575, 765, 866
3. 567, 686, 786, 875
4. 98, 346, 908, 987
5. 153, 466, 541, 764

Exercise 18

1. 432, 423, 242, 124
2. 764, 574, 475, 354
3. 977, 800, 796, 658
4. 932, 439, 293, 202
5. 908, 891, 890, 809

Exercise 19

1. 496, 558
2. 579, 778
3. 800, 907
4. 649, 748
5. 799, 495
6. 100, 190

Answers to Unit 3

Exercise 1

1. 10 2. 10 3. 10 4. 13
5. 15 6. 12 7. 10 8. 16

Exercise 2

1. 78 2. 52 3. 91 4. 47
5. 52 6. 65 7. 74 8. 28
9. 51 10. 32

Exercise 3

1. 84 2. 73 3. 81 4. 84
5. 77 6. 97 7. 79 8. 99

Exercise 4

2. Rs 90 3. 85 books 4. Rs 90 5. 30 bananas

Exercise 5

1. 649 2. 938 3. 699 4. 889

Exercise 6

1. 578 stamps 2. 795 books 3. Rs 995 4. 788 pages

Exercise 7

1. 594 2. 362 3. 1190 4. 830
5. 503 6. 439 7. 614 8. 1005

Exercise 8

1. 410 2. 607 3. 598 4. 690
5. 923 6. 836

Exercise 9

1. 237 2. 700, 1275 3. 1045 4. 525 5. 1042

Exercise 10

1. 17 2. 18 3. 49 4. 54
5. 14 6. 27 7. 15 8. 37
9. 19 10. 32

Exercise 11

Circle:

1. 48, 30 2. 94, 76 3. 45, 27
4. 47, 10 5. 84, 47 6. 55, 18

Exercise 12

2. 15 monthly magazines 3. Rs 13 4. Rs 77
5. Rs 16

Exercise 13

1. 111 2. 211 3. 212 4. 210
5. Rs 112 6a. 110 6b. 135

Exercise 14

1. 169 2. 371 3. 3 4. 356
5. 328 6. 284 7. 132 8. 170

Exercise 15

1. 150 pages 2. 1029 km 3. Rs 900 4. 130 people
5. Rs 100

Exercise 16

1. 10 2. 2 3. 1 4. 0
5. 20 6. 4 7. 0 8. 2
9. 5 10. 21

Exercise 17

1. 12 2. 18 3. 45 4. 14
5. 32 6. 0 7. 24 8. 1
9. 27 10. 2

Exercise 18

1. 28 2. 24 3. 27 4. 30
5. 16 6. 36 7. 10 8. 80

Exercise 19

1. 6 flowers 2. 36 km 3. 40 coconuts 4. Rs 45
5a. 14 balloons 5b. Rs 10 5c. Rs 70 6. Rs 20
7. 15 saplings 8. 25 hours

Exercise 20

1. 2 flowers 2. 5 fish 3. 3 pieces 4. 3 balloons
5. 5 nuts 6. 2 cones 7. 5 bananas 8. 9 sailboats

Exercise 21

1. 3, 3 2. 5, 5 3. 5, 5 4. 5, 5
5. 4, 4 6. 4, 4

Exercise 22

- | | | | |
|----------------------|----------------------|-----------------------|----------------------|
| 2. $2 \times 7 = 14$ | 3. $3 \times 6 = 18$ | 4. $2 \times 10 = 20$ | 5. $4 \times 7 = 28$ |
| $7 \times 2 = 14$ | $6 \times 3 = 18$ | $10 \times 2 = 20$ | $7 \times 4 = 28$ |
| $14 \div 7 = 2$ | $18 \div 3 = 6$ | $20 \div 2 = 10$ | $28 \div 7 = 4$ |
| $14 \div 2 = 7$ | $18 \div 6 = 3$ | $20 \div 10 = 2$ | $28 \div 4 = 7$ |

Exercise 23

- | | | | |
|------|------|------|-------|
| 1. 6 | 2. 6 | 3. 7 | 4. 9 |
| 5. 9 | 6. 9 | 7. 9 | 8. 10 |

Exercise 24

- | | | | |
|-------|-------|-------|-------|
| 1a. 4 | 1b. 6 | 2a. 7 | 2b. 4 |
| 3a. 9 | 3b. 7 | 4a. 6 | 4b. 9 |

Exercise 25

- | | | | |
|--------------|--------------|--------------|----------|
| 1. Rs 151 | 2a. 385 cans | 2b. 515 cans | 3. Rs 10 |
| 4. Rs 75 | 5a. Rs 303 | 5b. Rs 330 | 6. Rs 40 |
| 7. 28 people | 8. 11 cars | | |

Answers to Unit 4**Exercise 1**

Each illustration is divided into halves by drawing a vertical line across the middle.

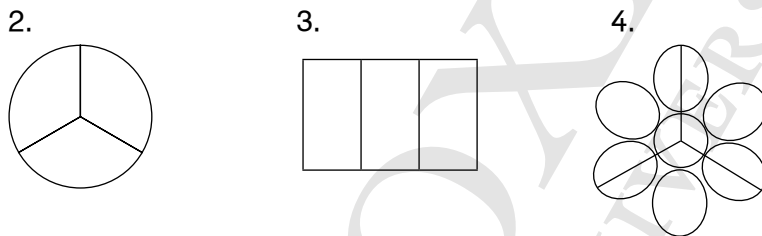
Exercise 2

Each illustration is divided into thirds by drawing lines as shown:

Exercise 3

- | | | | |
|------------------|------------------|------------------|-------------------|
| 1. $\frac{3}{6}$ | 2. $\frac{2}{5}$ | 3. $\frac{5}{8}$ | 4. $\frac{7}{10}$ |
|------------------|------------------|------------------|-------------------|

Exercise 4

- | | | | |
|------------------|------------------|-------------------|------------------|
| 1. $\frac{6}{8}$ | 2. $\frac{4}{6}$ | 3. $\frac{5}{10}$ | 4. $\frac{3}{7}$ |
|------------------|------------------|-------------------|------------------|

Exercise 5

Colour according to the fraction given.

Exercise 6

1st row: The circle and the rectangle are equally divided.

2nd row: The square is equally divided.

Exercise 7

1. $3, \frac{1}{3}$ 2. $4, \frac{1}{4}$ 3. $2, \frac{1}{2}$

Exercise 8

1. $\frac{1}{2}, 2$ 2. $\frac{1}{4}, 4$ 3. $\frac{1}{2}, 2$

Exercise 9

1. $\frac{2}{8}$ 2. $\frac{2}{6}$ 3. $\frac{6}{7}$
4. $\frac{8}{8}$ 5. $\frac{5}{10}$ 6. $\frac{6}{10}$

Answers to Unit 5**Exercise 1**

1. m 2. cm 3. m 4. m 5. cm 6. cm

Exercise 2

nail file: 10 cm, pencil: 6 cm, key: 5 cm, screw: 6 cm

Exercise 3

1. line A 2. line B 3. line A 4. line B 5. line D

Exercise 4

Children draw lines of the given lengths.

Exercise 5

1. 177 cm 2. 134 cm 3. 20 cm 4. 17 cm

Exercise 6

The answers would vary for this except for the Maths Wise Book 2.

Exercise 7

1. 100 g 2. 1 g 3. 800 g 4. 3 g
5. 1 g 6. 300 g

Exercise 8

- 1a. 838 g 1b. 798 g 2. 655 g 3. 370 g 4. 2175 g
6. maximum weight peaches, minimum weight baked beans, 695 g

Exercise 9

1. more than 1 l
2. less than 1 l
3. more than 1 l
4. more than 1 l
5. less than 1 l

Exercise 10

Children circle the following;

1. watering can
2. jug
3. cup
4. fish bowl

Exercise 11

5 ml, 250 ml, 3 l, 1 l, 20 l

Exercise 12

1. 90 ml, 365 ml, 680 ml, 2 l
2. 125 l
3. 600 ml
4. 225 ml
5. 825 ml

Answers to Unit 6

Exercise 1

1. 9:00, 9 o'clock
2. 6:00, 6 o'clock
3. 4:00, 4 o'clock
4. 11:30, half past 11
5. 5:45, quarter to 6
6. 2:15, quarter past 2

Exercise 2



Exercise 3

1. 3:40, three forty
2. 11:25, eleven twenty-five

3. 4:55, four fifty-five

4. 7:20, seven twenty

5. 2:50, two fifty

6. 8:10, eight ten

7. 4:15, four fifteen

8. 7:45, seven forty-five

Exercise 4

12:15 3:55 8:30 2:35

10:45 6:50 4:00 8:50

Exercise 5

(√) 15 minutes, (√) 3 minutes, (√) 8 hours,

(√) 7 days, (√) 1 minute, (√) 2 hours

Exercise 6

1. a.m. 2. p.m. 3. a.m.

4. p.m. 5. p.m.

1. before 2. after 3. after

4. before 5. before

1. after 2. after 3. before

4. after 5. before

1. 2 a.m. 2. 10 a.m. 3. noon 2 p.m. 8 p.m.

1. night time 2. day time 3. day time

4. night time 5. day time

1. a.m. 2. p.m. 3. both

4. a.m. 5. p.m. 6. p.m.

Exercise 7

1. February
2. 2
3. 29 days (February normally has 28 days, but it has 29 days in a leap year.)

Exercise 8

- | | |
|------------|-------------|
| 1a. Sunday | 1b. Tuesday |
| 2a. 18 | 2b. 26 |

Exercise 9

- | | | | |
|--------------|------------|----------------------|--|
| 1a. Saturday | 1b. Monday | | |
| 2. Tuesday | 3. 17th | 4. 3, 10, 17, 24, 31 | |

Exercise 10

Children make a list of public holidays for the current year.

Exercise 11

- | | | | |
|-------------|-----------|------------|-----------|
| 1. Muharram | 2. Ramzan | 3. Shawwal | 4. Zilhaj |
| 5. Zilhaj | 6. Rajab | | |

Answers to Unit 7

Exercise 1

- | | |
|---|--------------|
| 1. circle | 2. rectangle |
| 3. circles on the base and top of the can | 4. square |

Exercise 2

4 small and 1 big square, 4 triangles

Exercise 3

circle the chocolate bar, circle the road sign, circle the floppy disk

Exercise 4

Children draw the figures exactly as given and then colour the lines as stated. Guide them, checking their work.

The straight line, XY, is the shortest.

Exercise 5

Children measure all routes and find that the straight line is the shortest.

Exercise 6

Check that the children draw exact measures.

Exercise 7

H = Horizontal

V = Vertical

O = Oblique

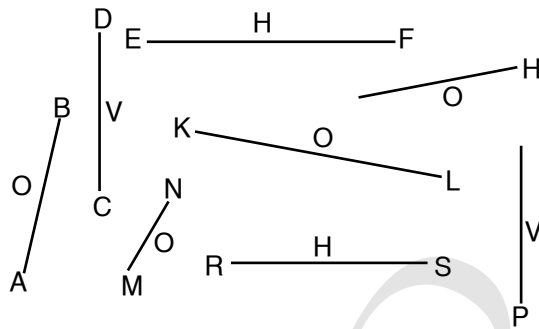

Exercise 8

Children colour the straight line

Answers to Unit 8

Exercise 1

33 pies

Exercise 2

1. HTO
2. HTO
3. HTO
4. HTO
5. HTO

Exercise 3

1. 299
2. 698
3. 208
4. 325
5. 850
6. 610

Exercise 4

1-digit numbers: 9, 7

2-digit numbers: 32, 56, 99, 29, 88

3- digit numbers: 820, 370, 299, 750, 999

Exercise 5

1. 140, 144
2. 322, 324
3. 260, 261
4. 900, 901, 903, 904

Exercise 6

- 98, 190, 214, 790
- 93, 100, 129, 895
- 156, 175, 492, 612
- 111, 222, 555, 777

Exercise 7

- 499, 490, 451, 419, 49
- 957, 819, 387, 297, 197
- 876, 867, 675, 655, 568
- 901, 832, 671, 444, 211

Exercise 8

- 726
- 873
- 168

Exercise 9

- $\frac{4}{8}$
- $\frac{3}{6}$
- $\frac{2}{4}$



Exercise 10**Circle: 4 buttons**

$\frac{1}{4}$ of 8 is 2 buttons

2. buttons

$\frac{1}{5}$ of 15 is 3 buttons

Exercise 11

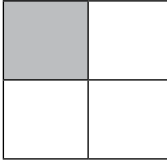
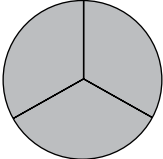
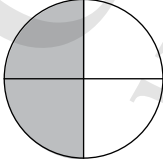
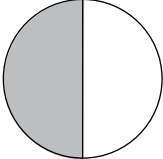
- 
- 
- 
- 
- 
- 

Exercise 12

- | | | | |
|--------|--------|--------|--------|
| 1. 28 | 2. 67 | 3. 28 | 4. 48 |
| 5. 61 | 6. 90 | 7. 72 | 8. 101 |
| 9. 99 | 10. 66 | 11. 28 | 12. 78 |
| 13. 87 | 14. 32 | 15. 46 | 16. 8 |
| 17. 28 | 18. 5 | 19. 70 | 20. 79 |

Exercise 13

- Rs 115
- 49 cars
- 18 cups
- 24 items
- 13 fish
- 59 cards
- 16 trees
- 24 points

Exercise 14

- 6
- 28
- 10
- 40
- 44
- 30
- 48
- 50
- 55
- 110

Exercise 15

- 32 legs
- 25 hours
- 24 runs

Exercise 16

- 9
- 51
- 10
- 23
- 18
- 20

Exercise 17

- 2
- 9 beads
- 10 taxis, with 5 people left

Exercise 18

- 16 cms
- 19 metres 14 cms
- 20 kg
- 105 kg

Exercise 19

- 2 cups
- 4 cups
- bottle
- yes
- No

Exercise 20

spoon is 1, ink bottle is 2, cup is 3, glass is 4, vase is 5, fish bowl is 6, bucket is 7, swimming pool is 8

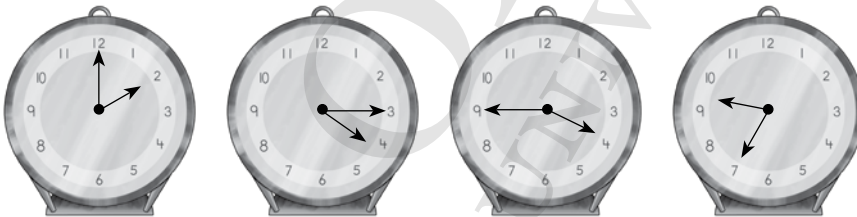
Exercise 21



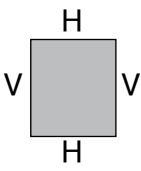
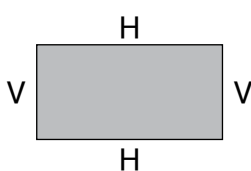
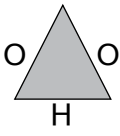
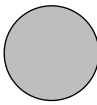

Exercise 22

1. p.m. 2. p.m. 3. a.m. 4. a.m.
5. a.m.

Exercise 23

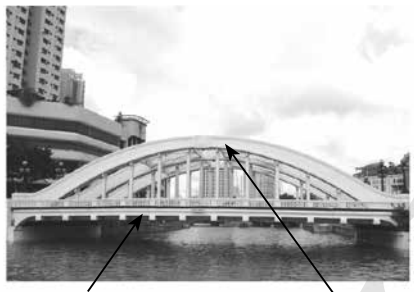
1. 
2. 
3. 
4. 
C = curved

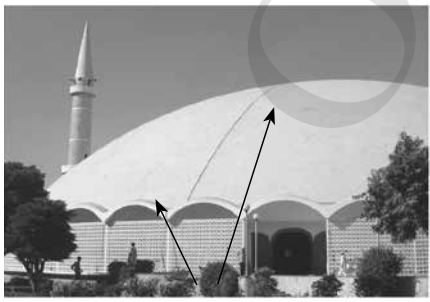
Exercise 24

1. 
horizontal line curved line
2. 
horizontal line
3. 
curved line
4. 
curved line straight lines

5.



vertical lines

6.



straight lines curved lines

OXFORD
UNIVERSITY PRESS

Glossary

>

>

a sign inserted between two numbers to show that the first number is greater than the second number

Example

$32 > 20$

<

<

a sign inserted between two numbers to show that the first number is less than the second number

Example

$32 < 40$

A

a.m.

we use a.m. to tell the time from 12 midnight to just before 12 noon

C

centimetre (cm)

a smaller unit of measure of length (see metre)

cone

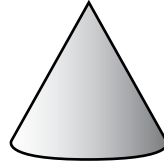

a three-dimensional figure with a flat face that is a circle and a curved surface

cube

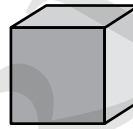

a three-dimensional figure with 6 flat faces that are squares

cuboid



a three-dimensional figure with 6 flat faces that are either squares or rectangles

curve

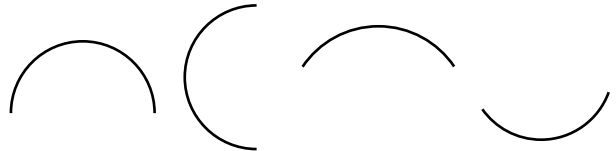

a line that bends and is not straight

cylinder

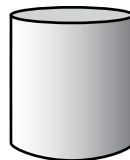

a three-dimensional figure with 2 flat faces that are circles and a curved surface

D

denominator

the number below the line in a fraction, showing the number of equal parts the whole is divided into

Example

$$\frac{3}{4} \leftarrow \text{denominator}$$

division

splitting a number into equal parts, also known as “fair sharing”

F

fraction

a part of a whole cut into equal parts

Example

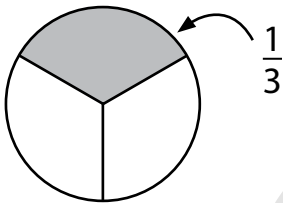

G

gram (g)

a smaller unit of mass (see kilogram)

K

kilogram (kg)

a unit of measure of mass, where $1 \text{ kg} = 1000 \text{ g}$

L

length

the measure of an object from one end to the other

line

a straight figure with no bends

Example

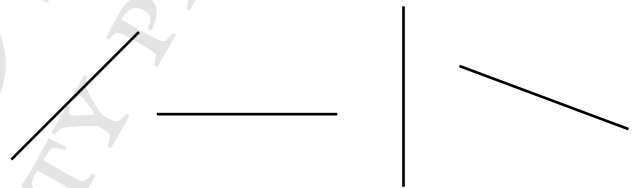

litre (l)

a unit of measure of volume

M

mass

the amount of matter in an object

metre (m)

a unit of measure of length, where $1 \text{ m} = 100 \text{ cm}$

multiplication

repeated addition of a number

multiplication table

shows the results of the same number multiplying a set of other numbers, usually in an increasing order numbers

Example

$1 \times 2 = 2$
$2 \times 2 = 4$
$3 \times 2 = 6$
$4 \times 2 = 8$
$5 \times 2 = 10$
$6 \times 2 = 12$
$7 \times 2 = 14$
$8 \times 2 = 16$
$9 \times 2 = 18$
$10 \times 2 = 20$

N

number pattern

the arrangement of numbers that follow a fixed pattern

Example

38, 36, 34, 32, 30, ?, ?
-2 -2 -2 -2

From the number pattern above, the next two numbers are 28 and 26.

numerator

the number above the line in a fraction, showing the number of equal parts that are to be added together

Example

$\frac{3}{4}$ ← numerator

P

p.m.

we use p.m. to tell the time from 12 noon to just before 12 midnight

pattern

a repeated set of shapes or numbers following a fixed rule

Example



Q

quarter circle

a figure that results when a circle is divided into four equal parts

Example

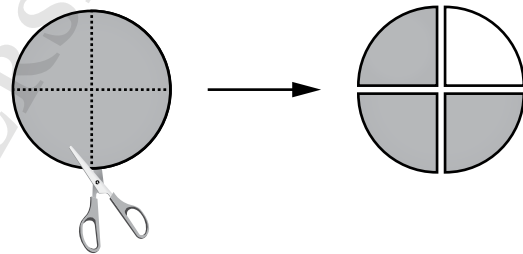

R

regrouping

to trade a number and make groups of ten when adding or subtracting

rupee

a currency of money used in countries such as Pakistan and India

S

semicircle

a figure that results when a circle is into two equal parts

Example

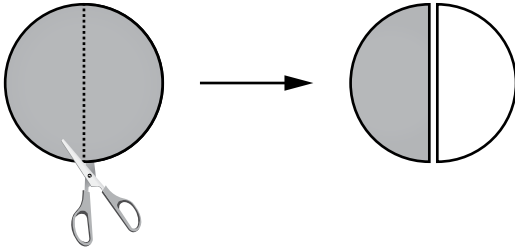

sphere

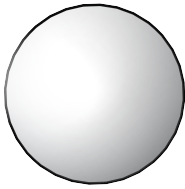

a three-dimensional figure with a curved surface

Example

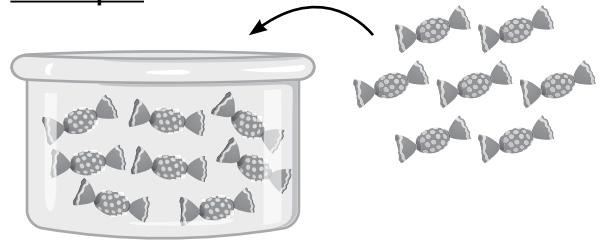

There are 8 sweets in a container. 7 more sweets are placed into the container. How many sweets are there in the container now?

$$8 + 7 = 15$$

There are 15 sweets in the container now.

W

weighing scale

an instrument that measures the mass of an object

Example

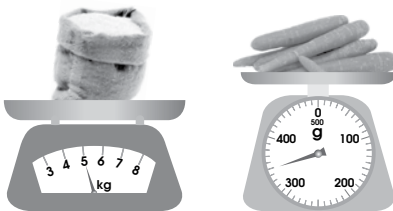

word problem

a mathematical story